

**PLAN VIEW**

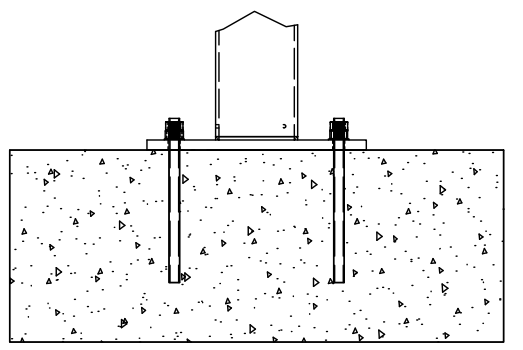

**CONCRETE MOUNT**

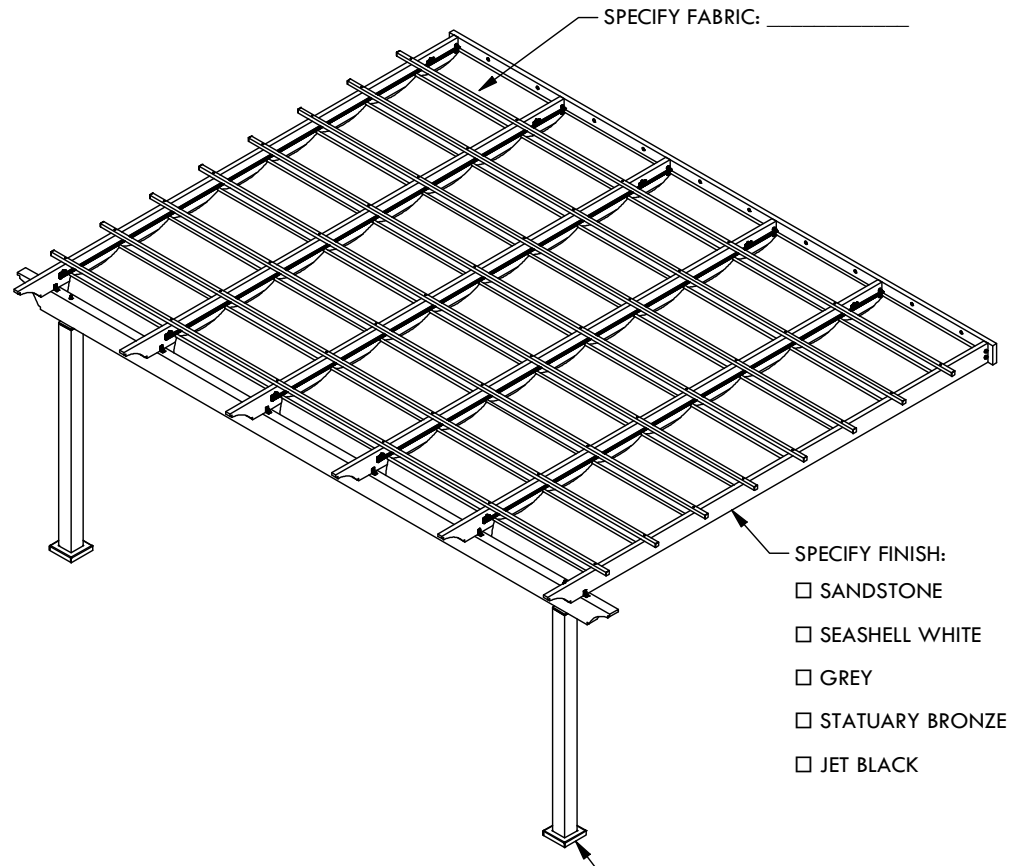
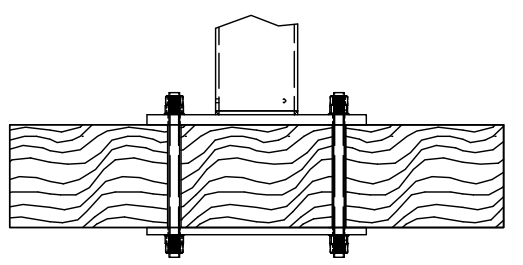

**FRAMING MOUNT**

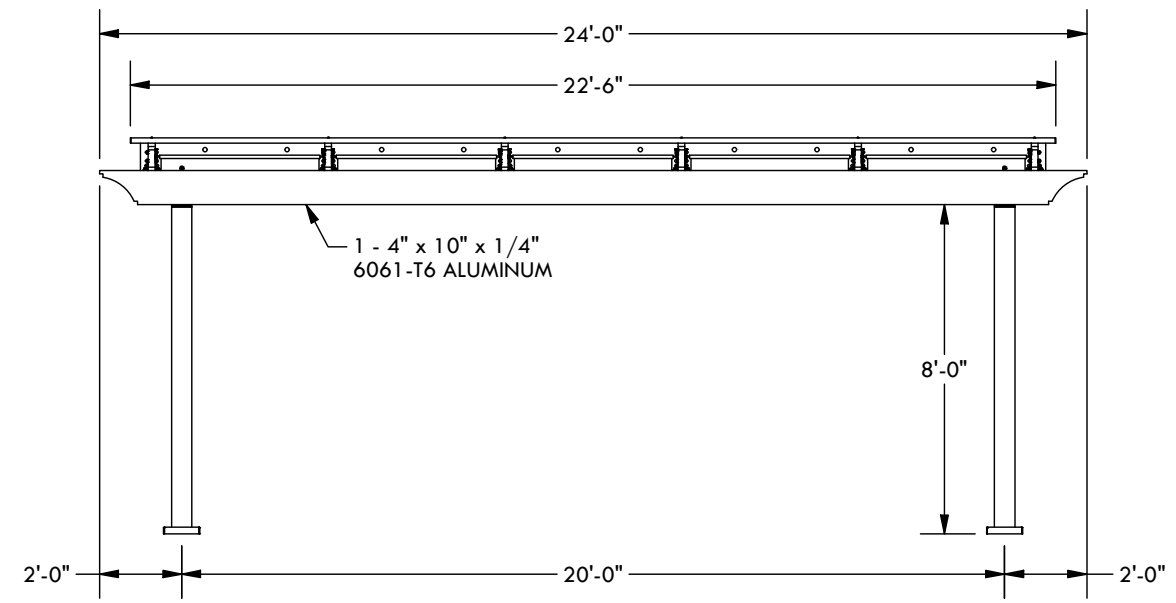

**WIDTH ELEVATION**

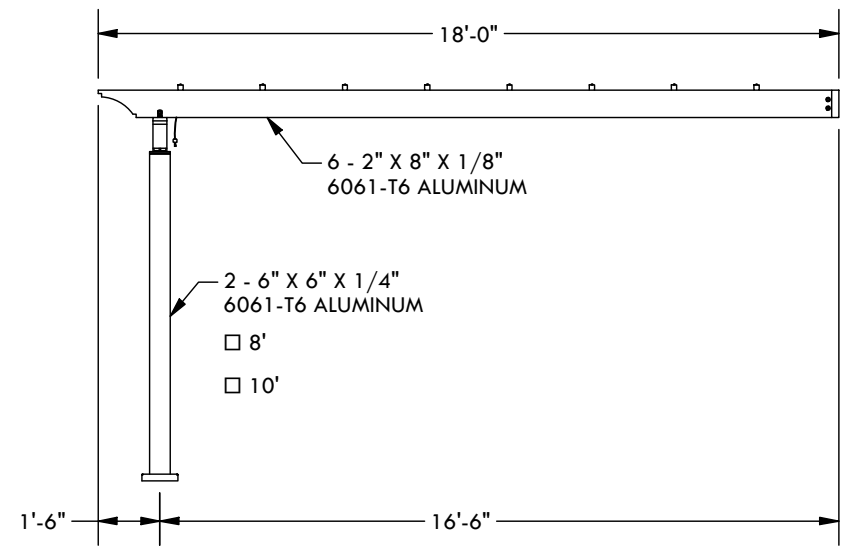

**PROJECTION ELEVATION**

DESCRIPTION			
<b>24' WIDE X 18' PROJECTION ATTACHED ATLAS</b>			
REV	BY	DESCRIPTION	DATE
	CL	INITIAL RELEASE	1/13/2026

© 2026 Structureworks

**STRUCTUREWORKS™**

www.structureworks.com 877.489.8064