

PLAN VIEW

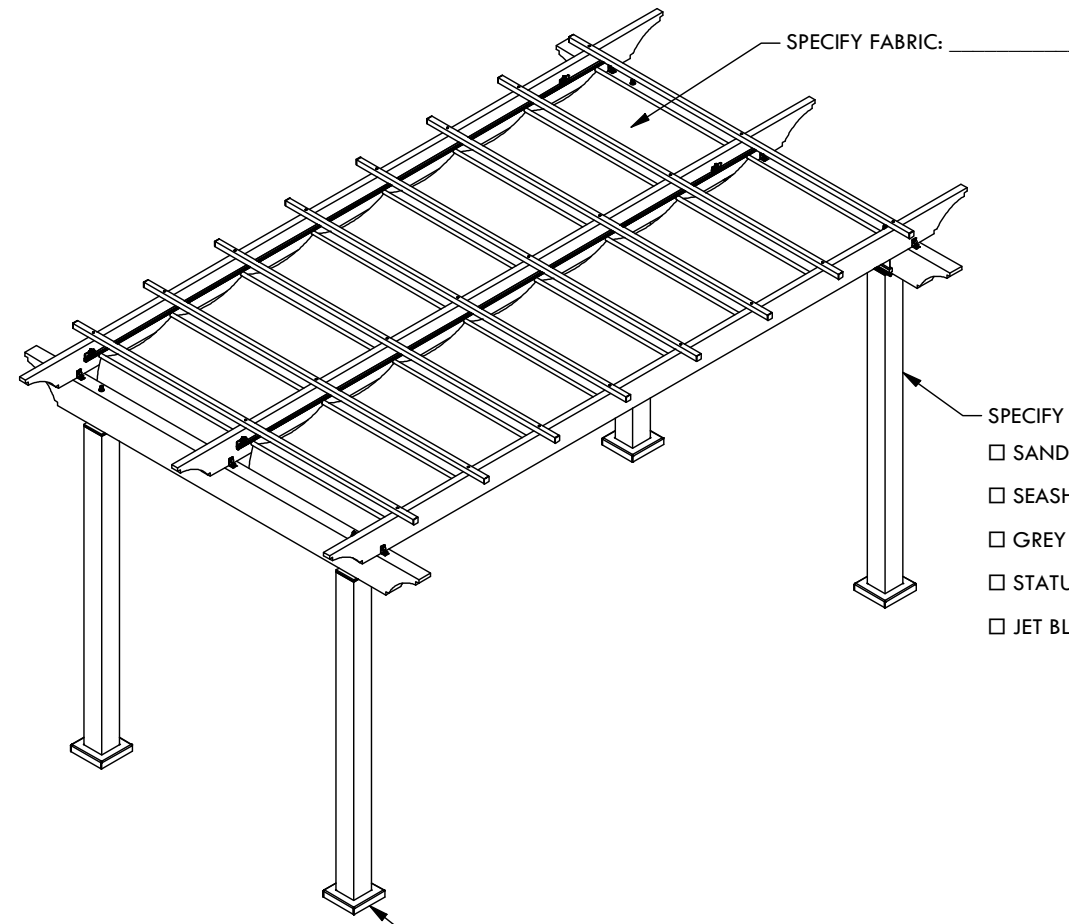

- SPECIFY FINISH:**
- SANDSTONE
 - SEASHELL WHITE
 - GREY
 - STATUARY BRONZE
 - JET BLACK

- SPECIFY BASE CONNECTION:**
- CONCRETE MOUNT
 - FRAMING MOUNT

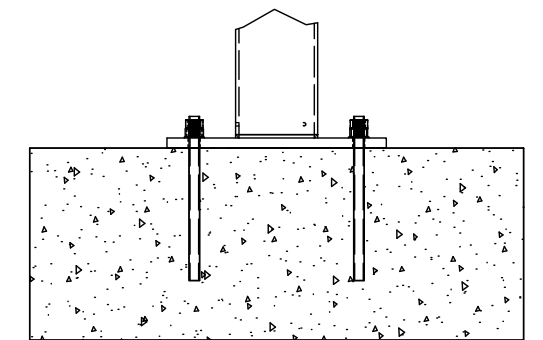

CONCRETE MOUNT

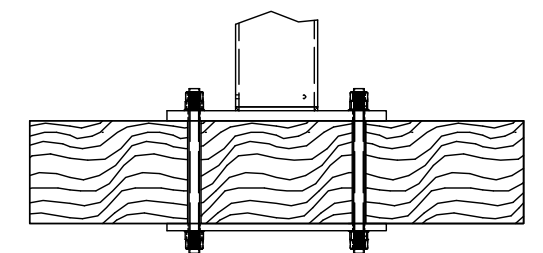

FRAMING MOUNT

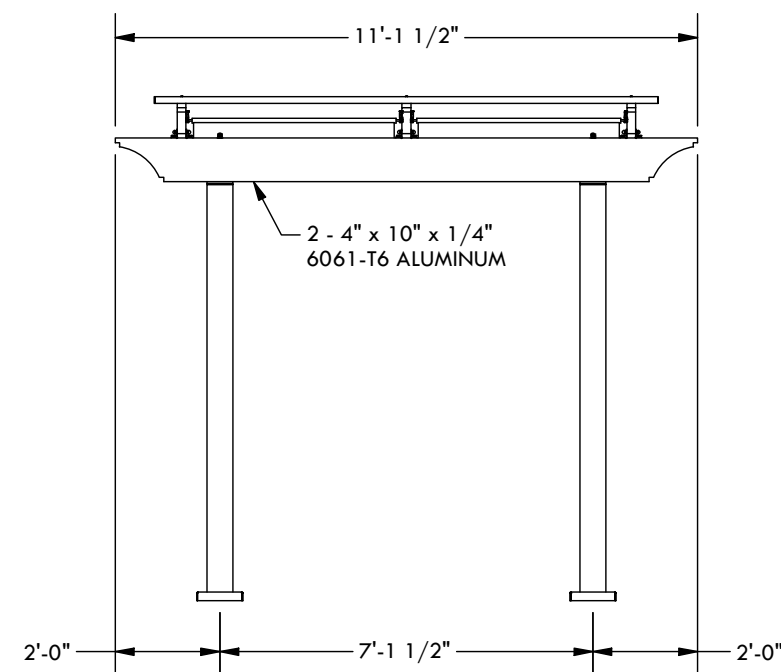

WIDTH ELEVATION

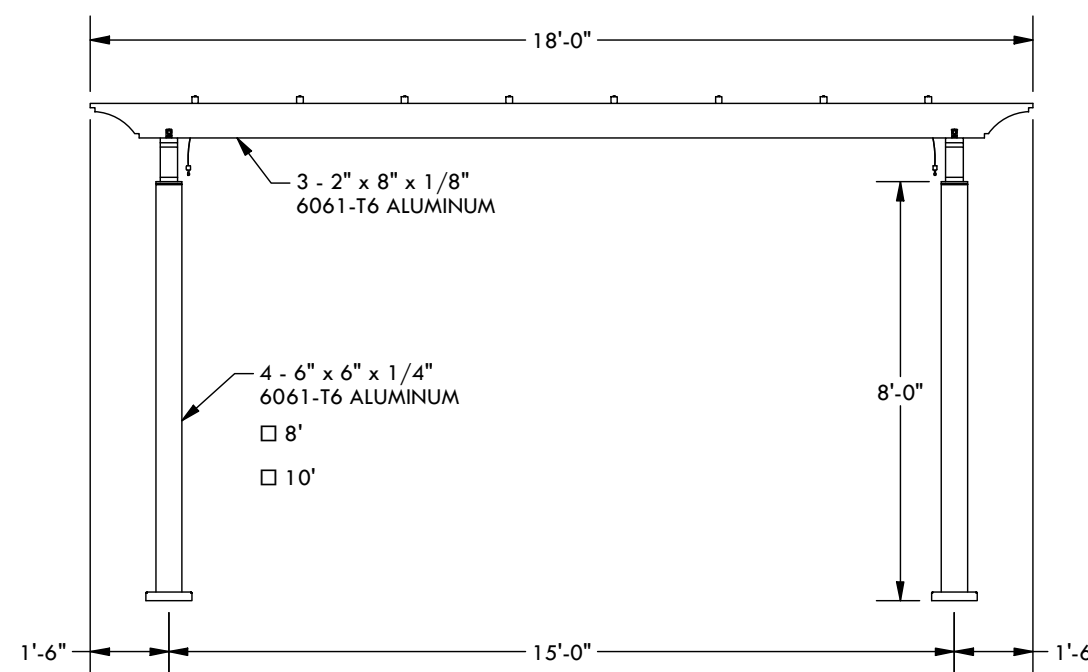

PROJECTION ELEVATION

DESCRIPTION			
11' WIDE X 18' PROJECTION FREESTANDING ATLAS			
REV	BY	DESCRIPTION	DATE
	CL	INITIAL RELEASE	1/13/2026

© 2026 Structureworks

STRUCTUREWORKS™

www.structureworks.com 877.489.8064