

CLASSIC TRIM STANDARD TRIM

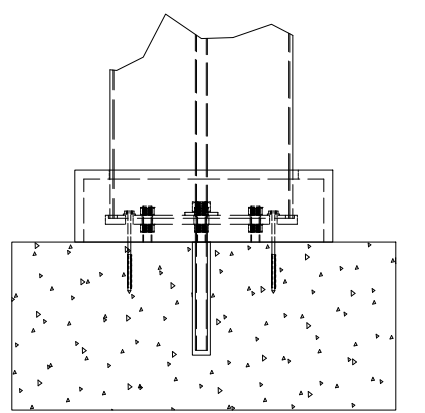

CONCRETE MOUNT

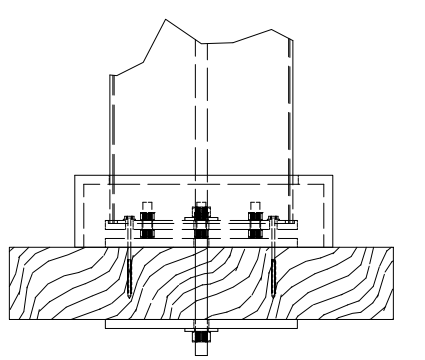

FRAMING MOUNT

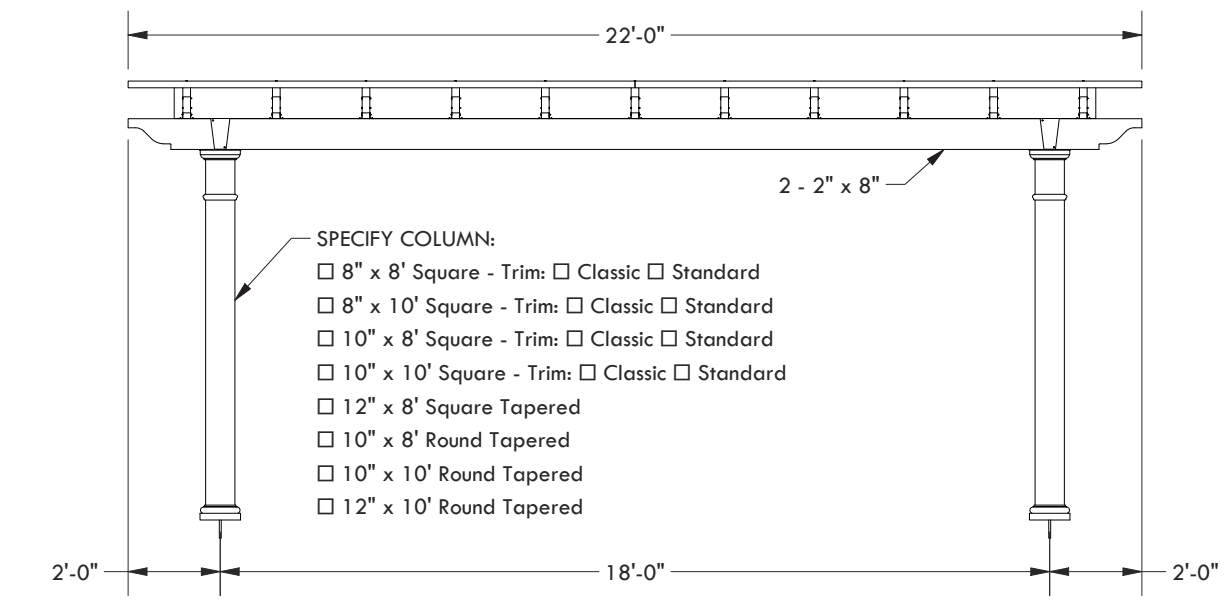

- SPECIFY COLUMN:
- 8" x 8' Square - Trim: Classic Standard
 - 8" x 10' Square - Trim: Classic Standard
 - 10" x 8' Square - Trim: Classic Standard
 - 10" x 10' Square - Trim: Classic Standard
 - 12" x 8' Square Tapered
 - 10" x 8' Round Tapered
 - 10" x 10' Round Tapered
 - 12" x 10' Round Tapered

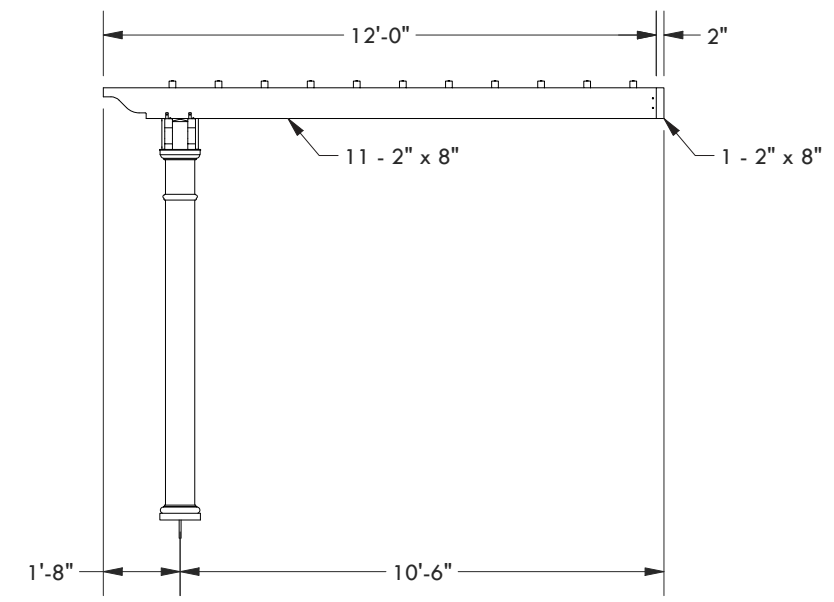

DESCRIPTION			
22' WIDE X 12' PROJECTION ATTACHED WILLIAMSBURG			
REV	BY	DESCRIPTION	DATE
1	NB	INITIAL RELEASE	04/02/21

STRUCTUREWORKS™
www.structureworks.com 877.489.8064

© 2021 Structureworks