

PLAN VIEW

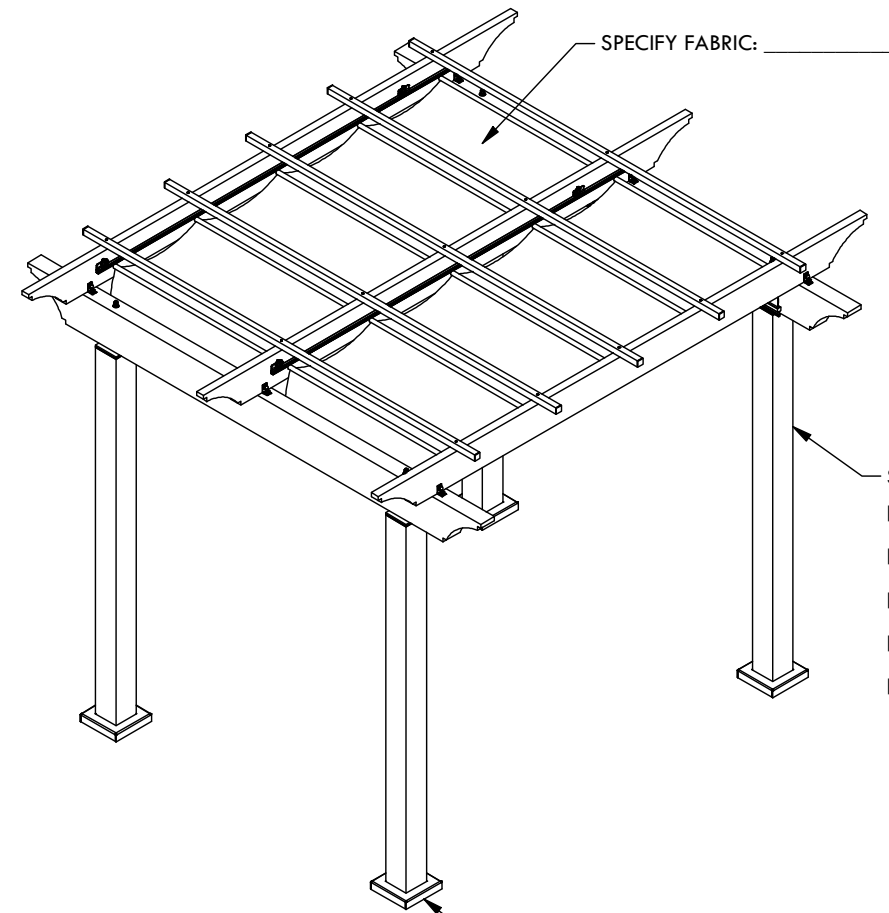

SPECIFY BASE CONNECTION:
 CONCRETE MOUNT
 FRAMING MOUNT

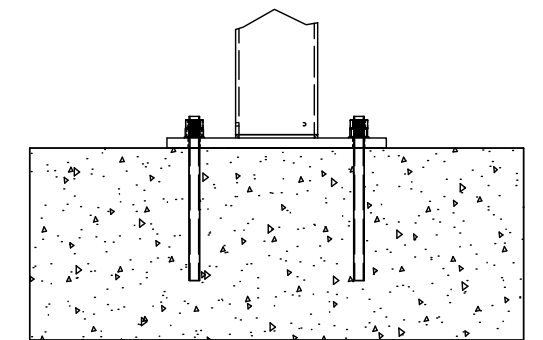

CONCRETE MOUNT

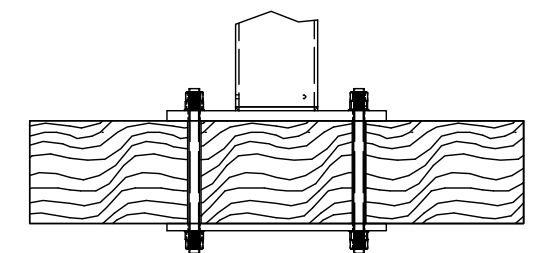

FRAMING MOUNT

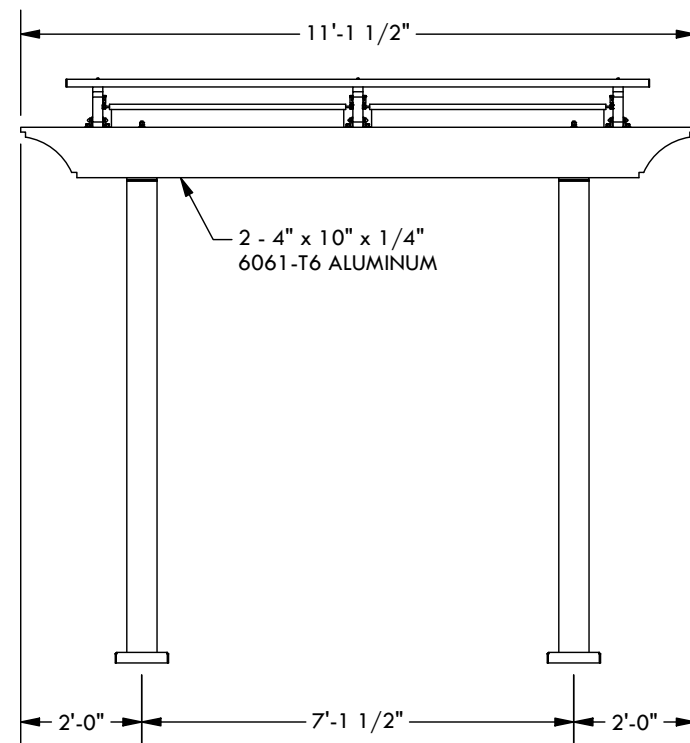

WIDTH ELEVATION

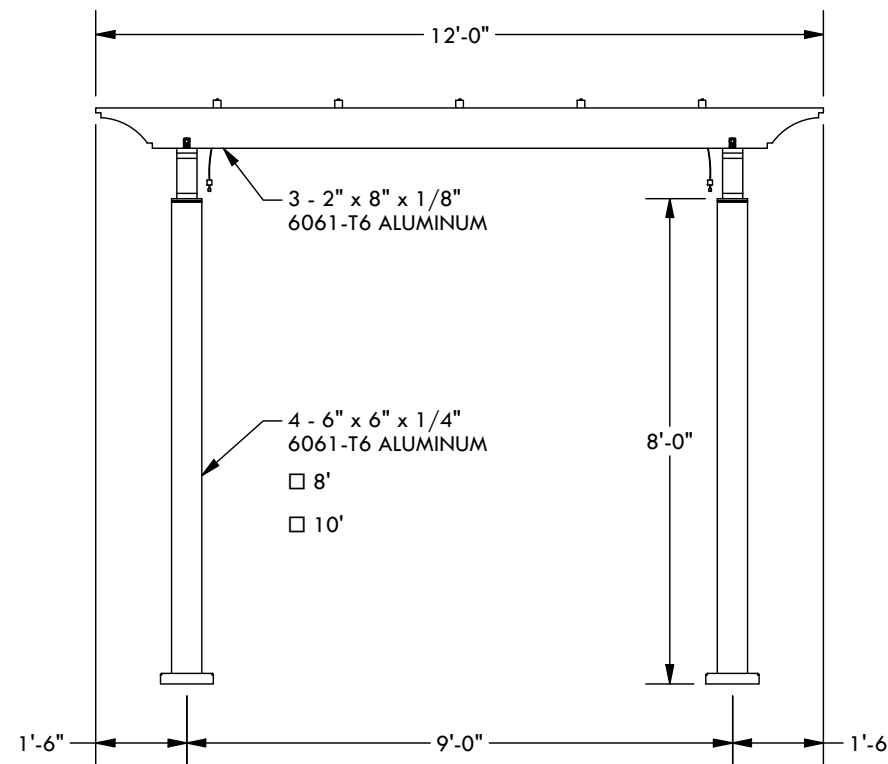

PROJECTION ELEVATION

DESCRIPTION			
11' WIDE X 12' PROJECTION FREESTANDING ATLAS			
REV	BY	DESCRIPTION	DATE
	CL	INITIAL RELEASE	1/13/2026

© 2026 Structureworks

STRUCTUREWORKS™

www.structureworks.com 877.489.8064