

**PLAN VIEW**

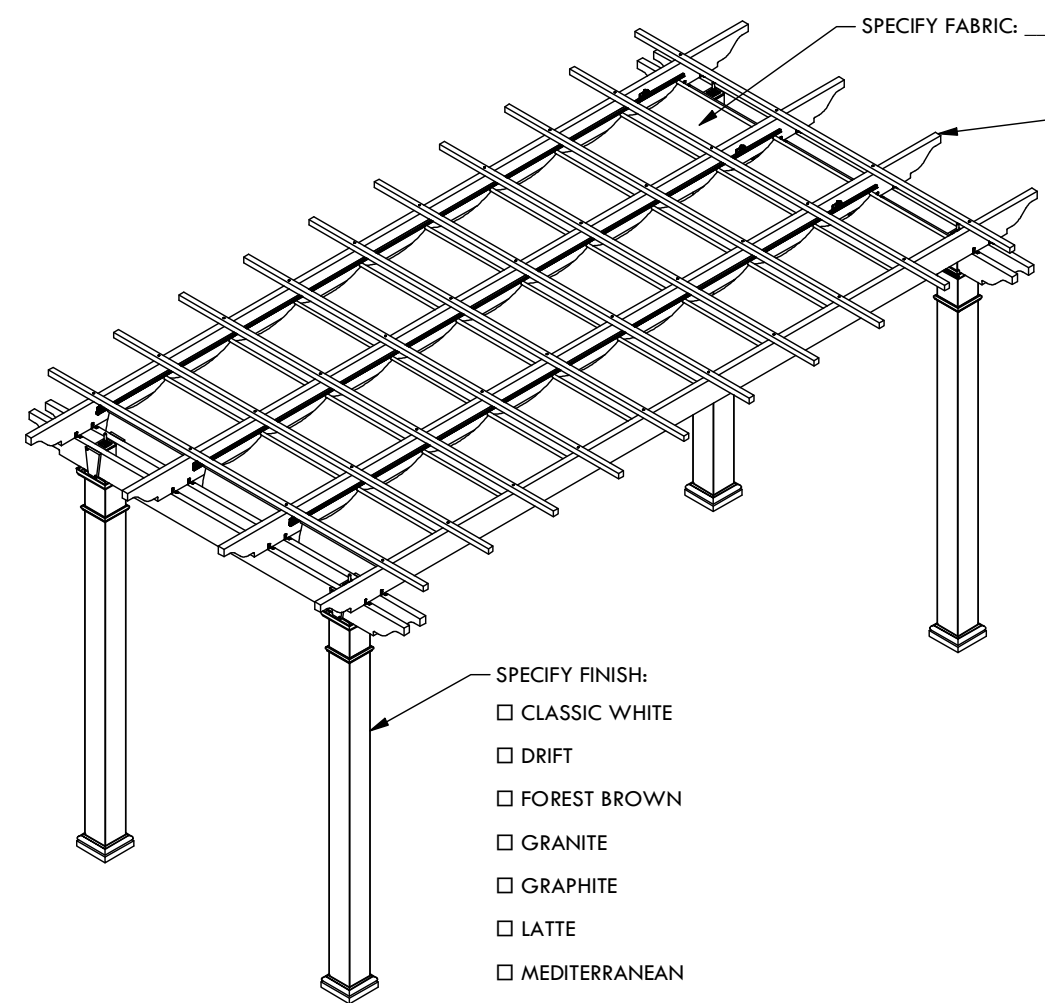

- SPECIFY FABRIC:** \_\_\_\_\_
- SPECIFY END STYLE:**
- ARCADIA
  - BELMONT
  - CLASSIC
  - CLIP
  - COAST
  - FLAT
  - SLIGHT
  - TRADITIONAL

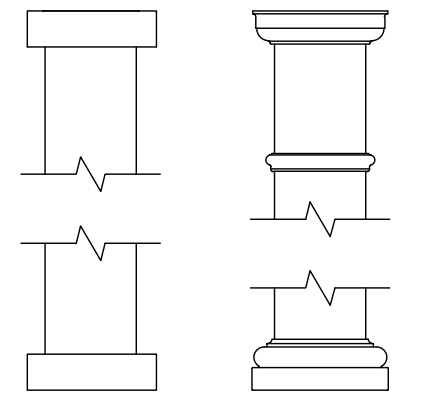

**CLASSIC TRIM      STANDARD TRIM**

- SPECIFY FINISH:**
- CLASSIC WHITE
  - DRIFT
  - FOREST BROWN
  - GRANITE
  - GRAPHITE
  - LATTE
  - MEDITERRANEAN
  - MIST
  - WALNUT

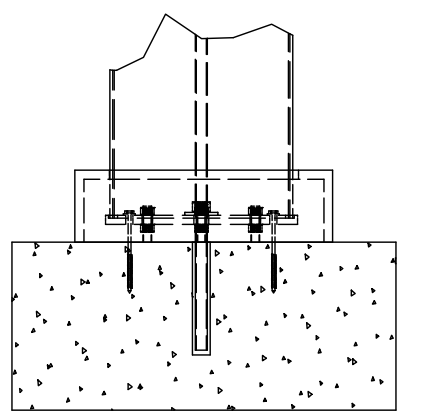

**CONCRETE MOUNT**

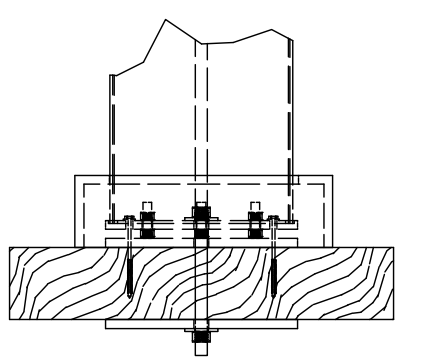

**FRAMING MOUNT**

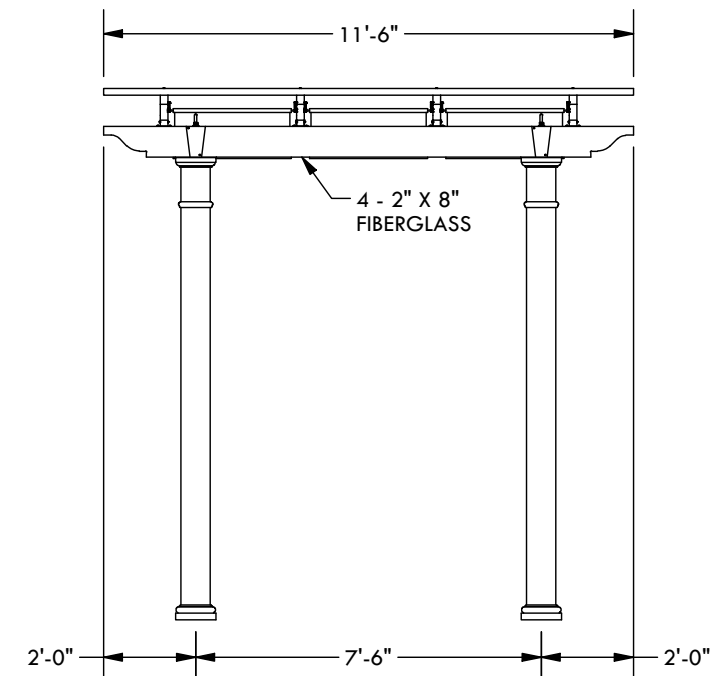

**WIDTH ELEVATION**

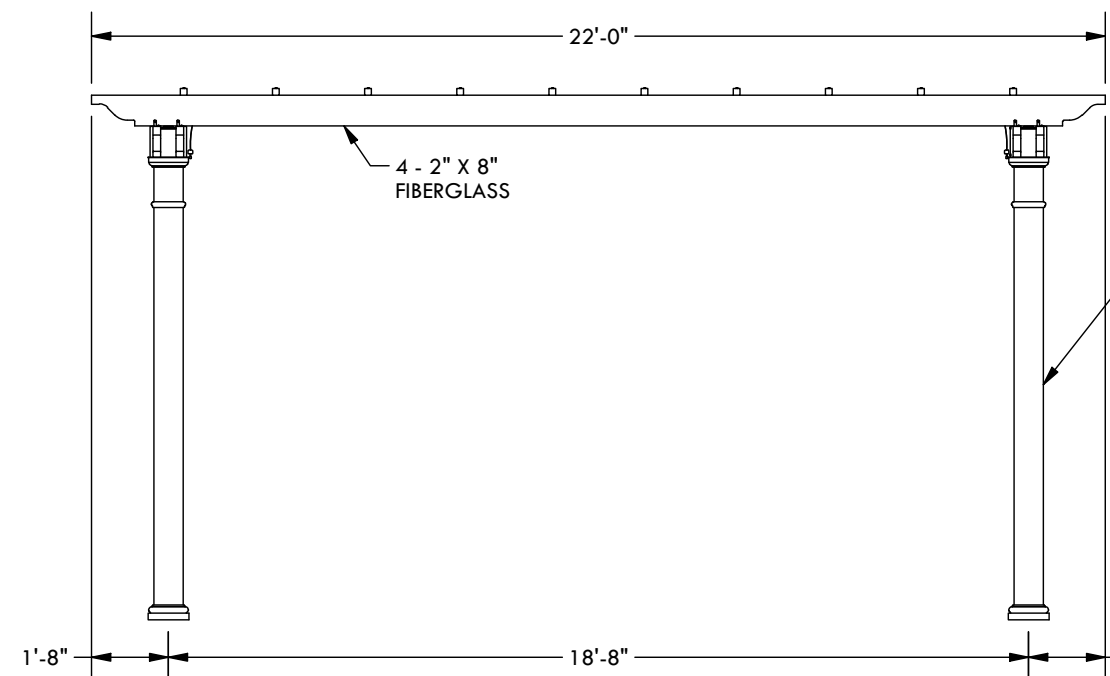

**PROJECTION ELEVATION**

- SPECIFY COLUMN:**
- 8" x 8' Square - Trim:  Classic  Standard
  - 8" x 10' Square - Trim:  Classic  Standard
  - 10" x 8' Square - Trim:  Classic  Standard
  - 10" x 10' Square - Trim:  Classic  Standard
  - 12" x 8' Square Tapered
  - 10" x 8' Round Tapered
  - 10" x 10' Round Tapered
  - 12" x 10' Round Tapered

DESCRIPTION			
<b>12' WIDE X 22' PROJECTION FREESTANDING WINDSOR</b>			
REV	BY	DESCRIPTION	DATE
	CL	INITIAL RELEASE	1/13/2026

© 2026 Structureworks

**STRUCTUREWORKS™**

www.structureworks.com 877.489.8064