

PLAN VIEW

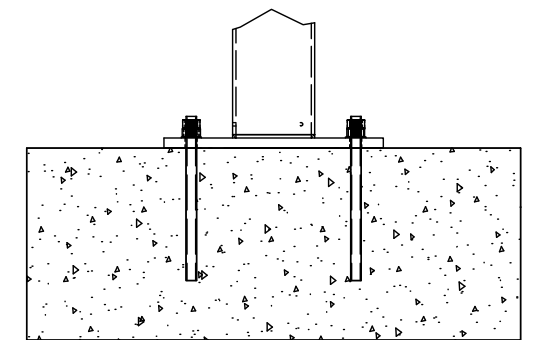

CONCRETE MOUNT

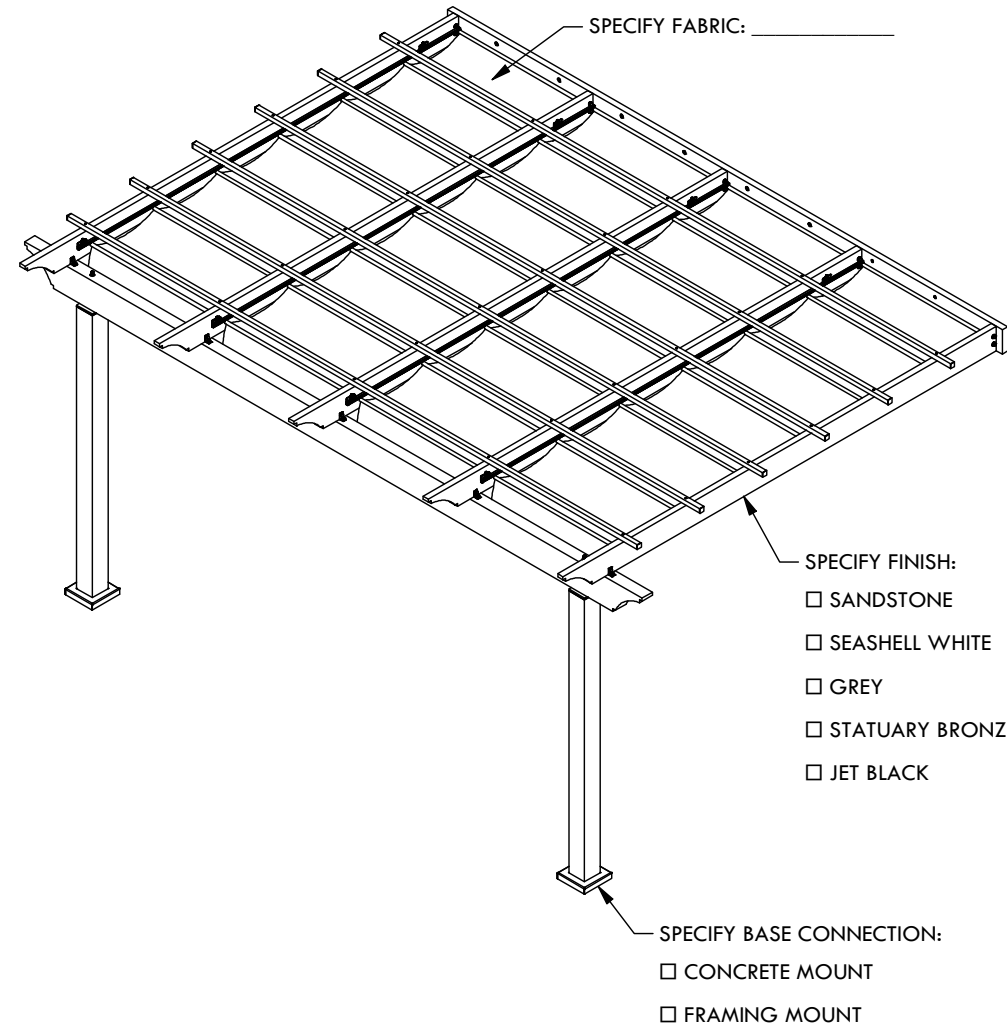
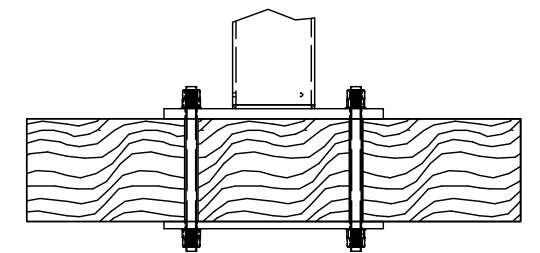

FRAMING MOUNT

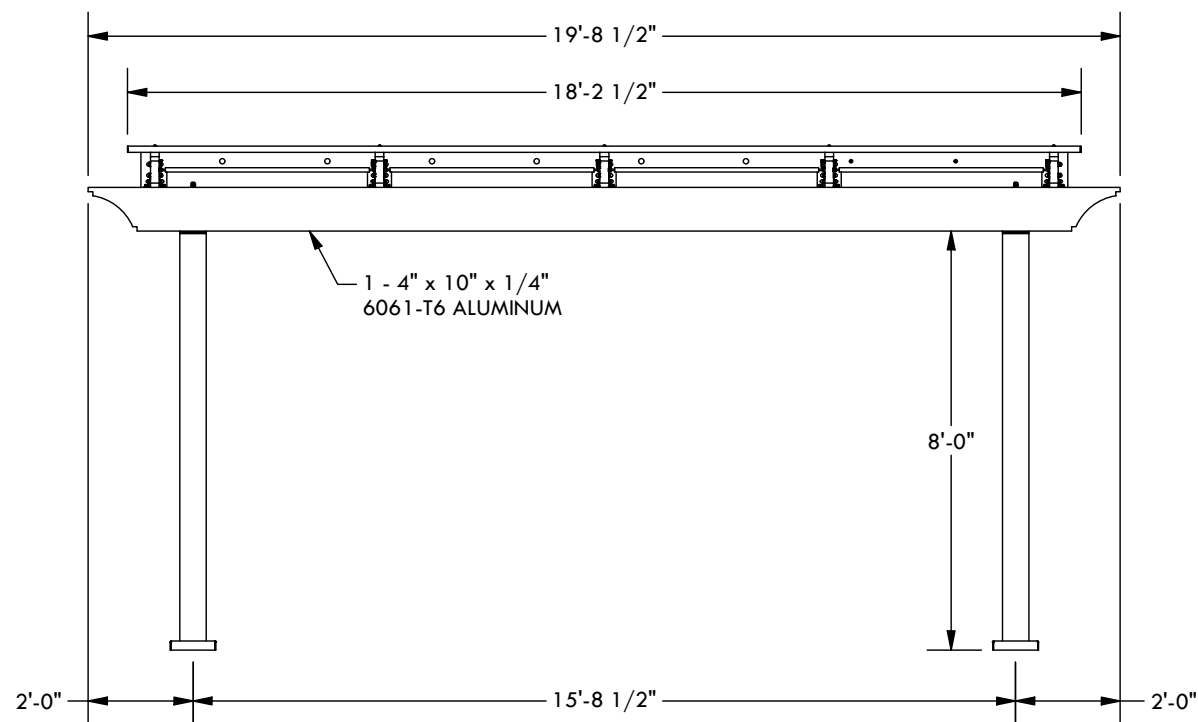

WIDTH ELEVATION

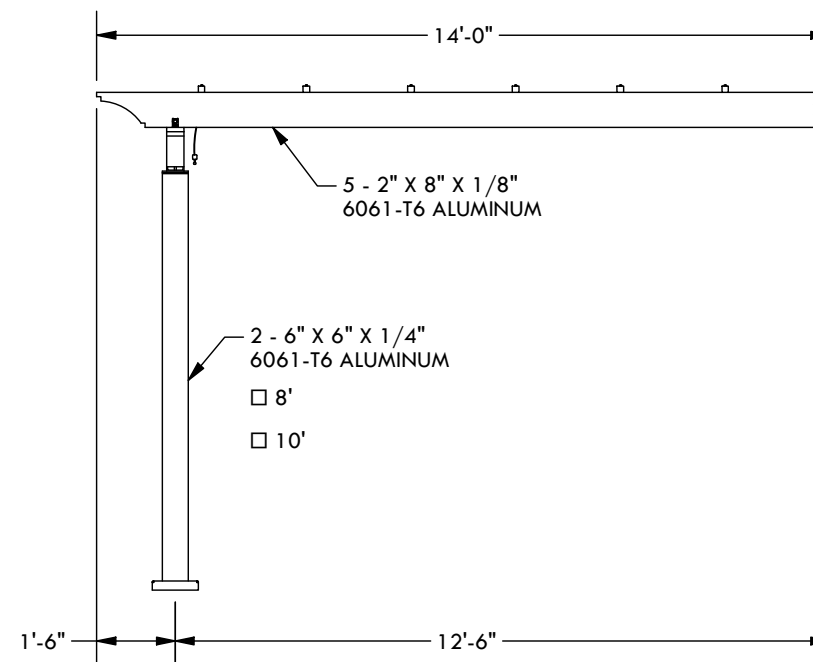

PROJECTION ELEVATION

DESCRIPTION			
20' WIDE X 14' PROJECTION ATTACHED ATLAS			
REV	BY	DESCRIPTION	DATE
	CL	INITIAL RELEASE	1/13/2026

© 2026 Structureworks

STRUCTUREWORKS™

www.structureworks.com 877.489.8064