

SPECIFY FINISH - STRUCTURE:
 UNPAINTED WHITE
 COLORLAST: _____

SPECIFY FINISH - COLUMN: _____

SPECIFY BASE CONNECTION:
 CONCRETE MOUNT
 FRAMING MOUNT

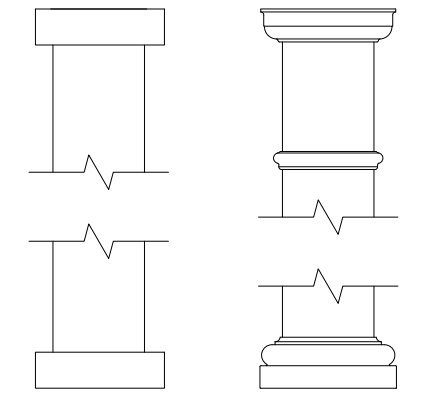

CLASSIC TRIM STANDARD TRIM

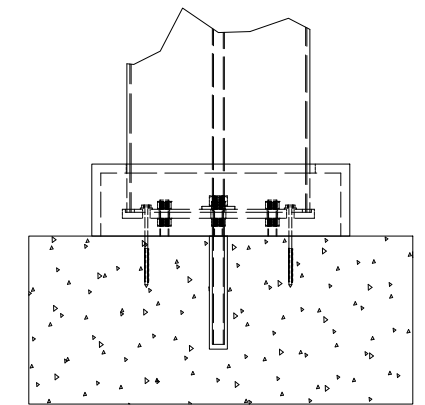

CONCRETE MOUNT

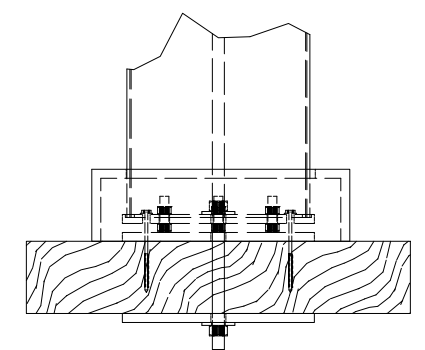

FRAMING MOUNT

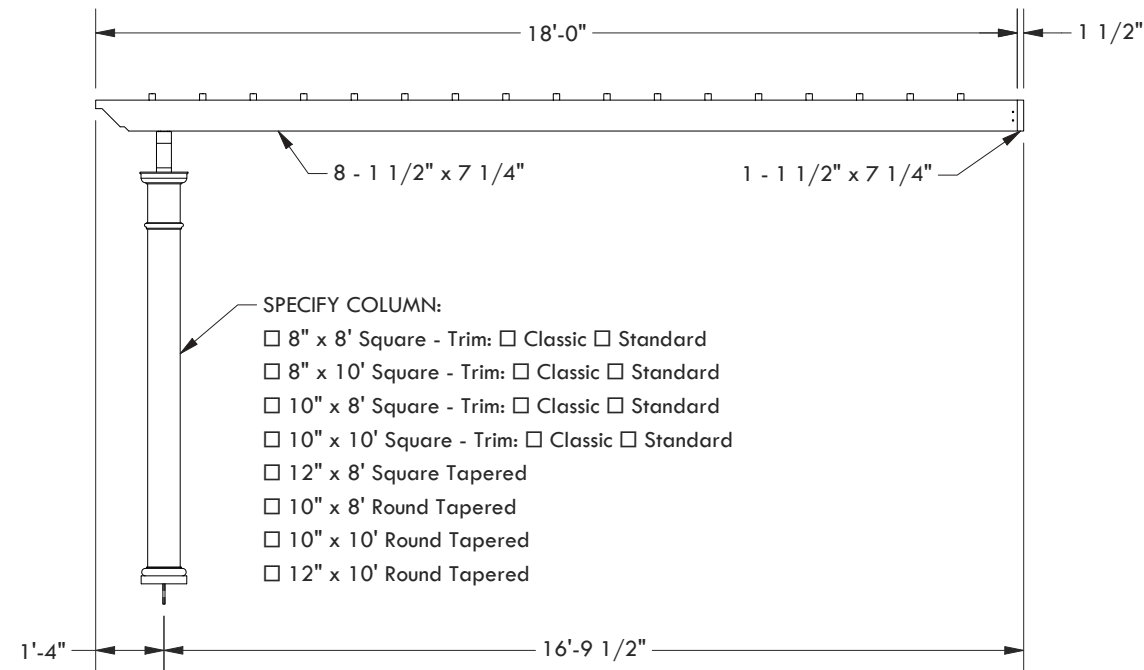
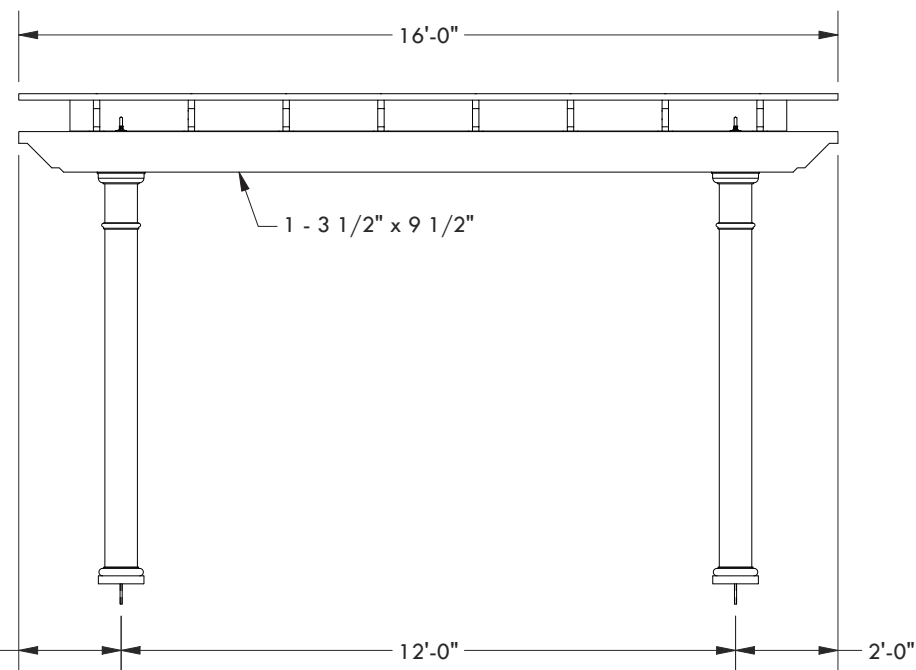

© 2021 Structureworks

DESCRIPTION			
16' WIDE X 18' PROJECTION ATTACHED TREX PERGOLA			
REV	BY	DESCRIPTION	DATE
1	NB	INITIAL RELEASE	03/31/21

Trex® Pergola™

www.trexpergola.com 888.908.4965