

CONCRETE MOUNT

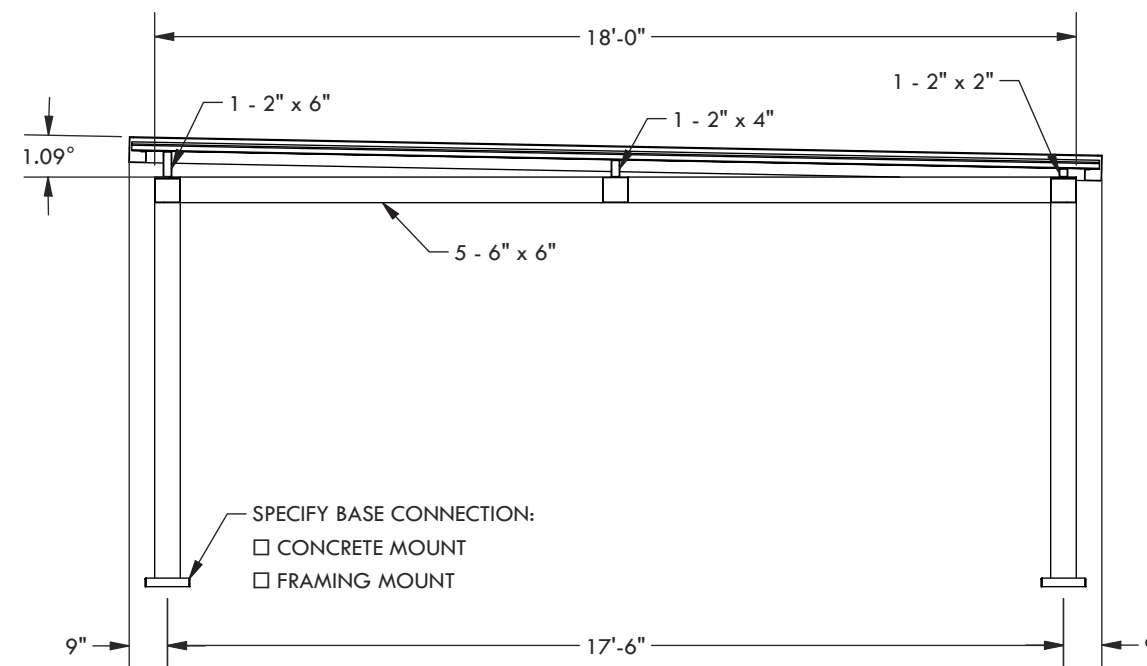

SECTION C-C

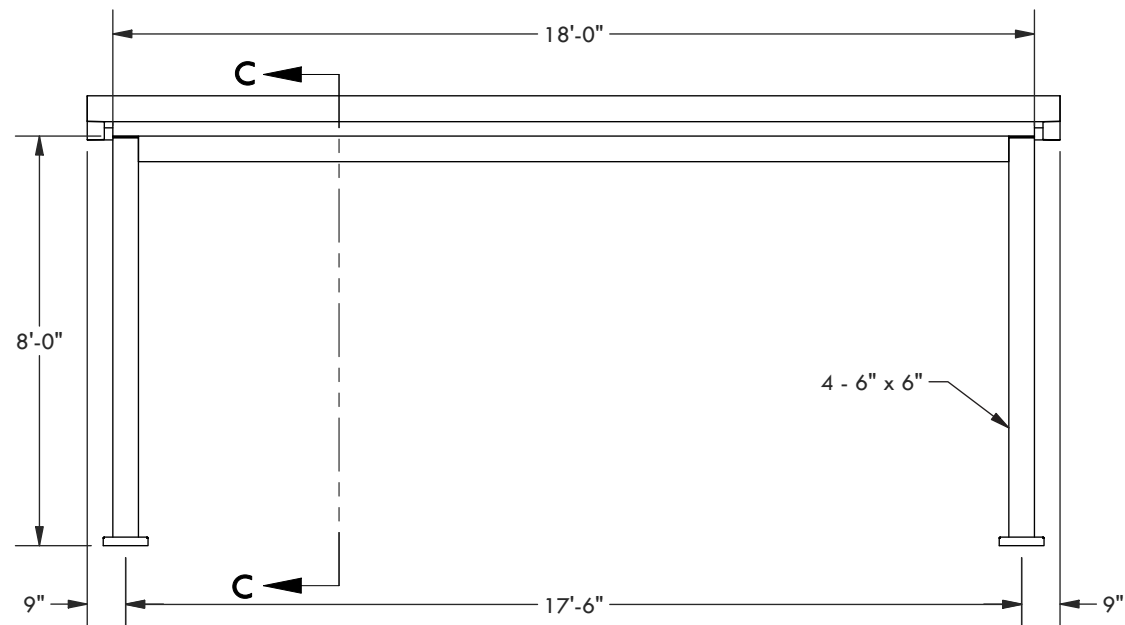
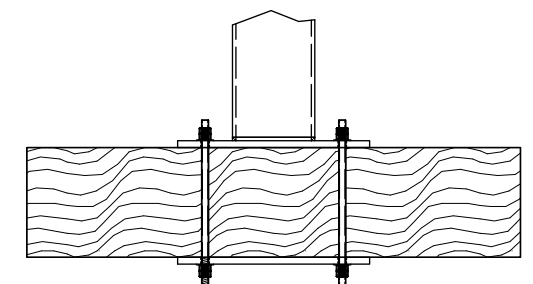

FRAMING MOUNT

DESCRIPTION			
18' WIDE x 18' PROJECTION FREESTANDING PAVILION			
REV	BY	DESCRIPTION	DATE
1	NB	INITIAL RELEASE	03/23/21

© 2021 Structureworks

STRUCTUREWORKS™

www.structureworks.com 877.489.8064