

CONCRETE MOUNT

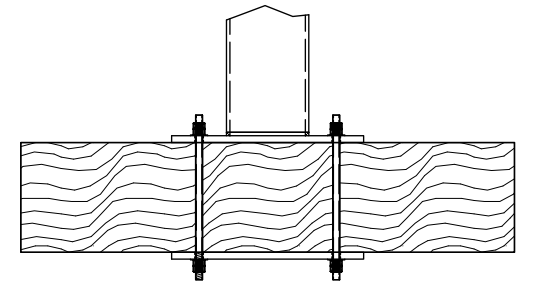

FRAMING MOUNT

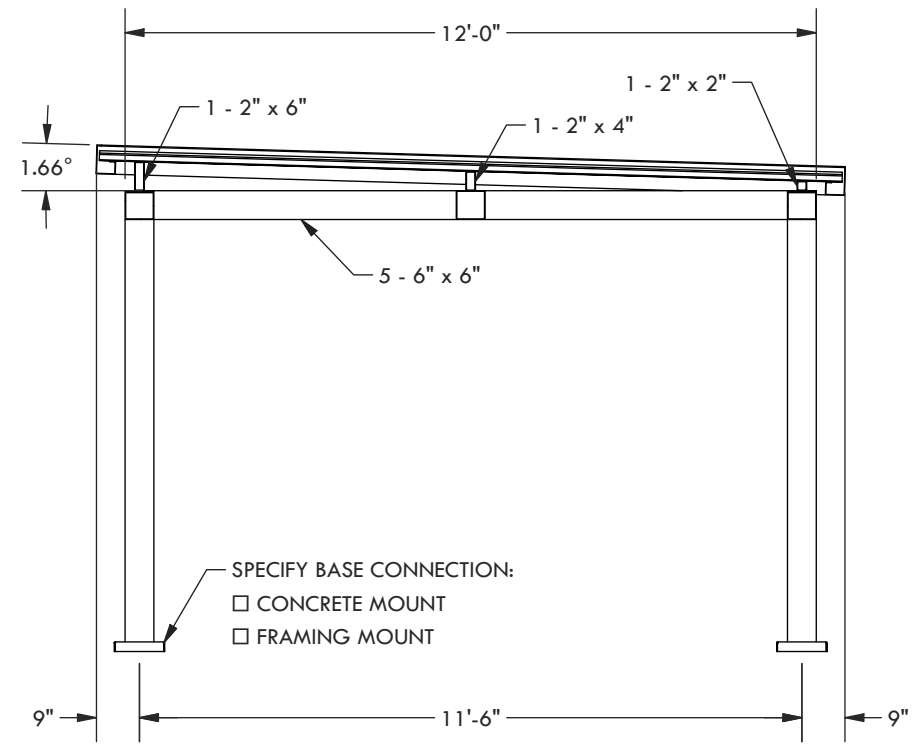
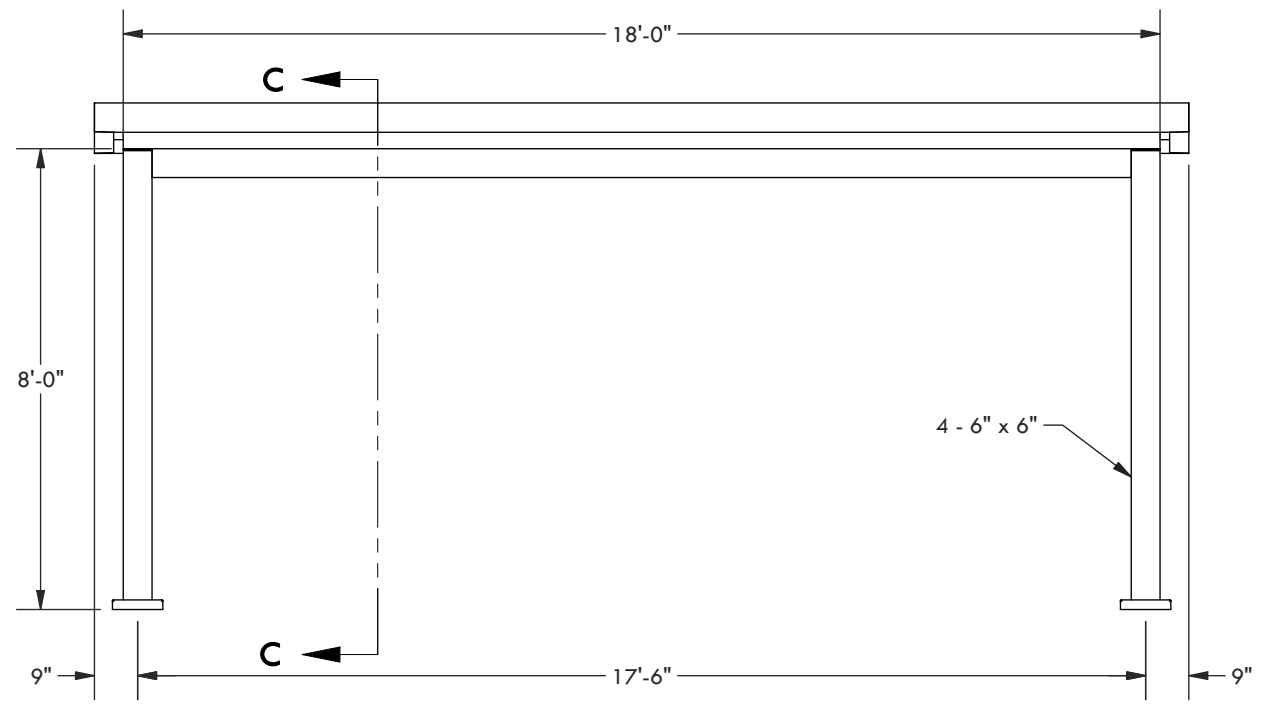

SPECIFY BASE CONNECTION:
 CONCRETE MOUNT
 FRAMING MOUNT

SECTION C-C

DESCRIPTION			
18' WIDE x 12' PROJECTION FREESTANDING PAVILION			
REV	BY	DESCRIPTION	DATE
1	NB	INITIAL RELEASE	03/23/21

© 2021 Structureworks

STRUCTUREWORKS™
 www.structureworks.com 877.489.8064