

CONCRETE MOUNT

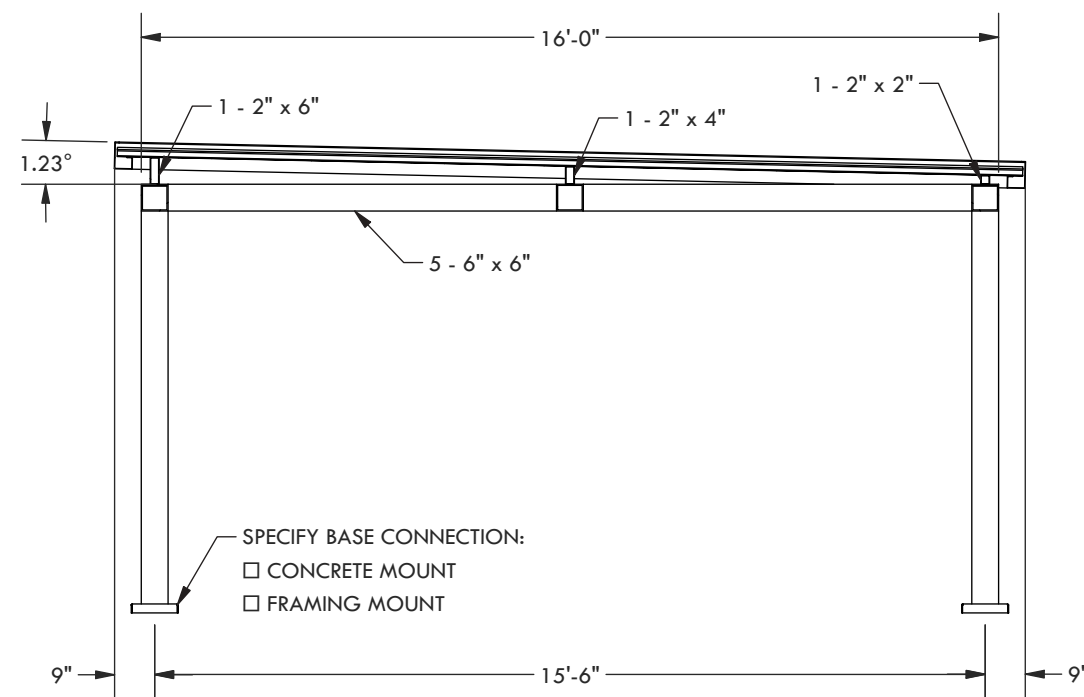

SECTION C-C

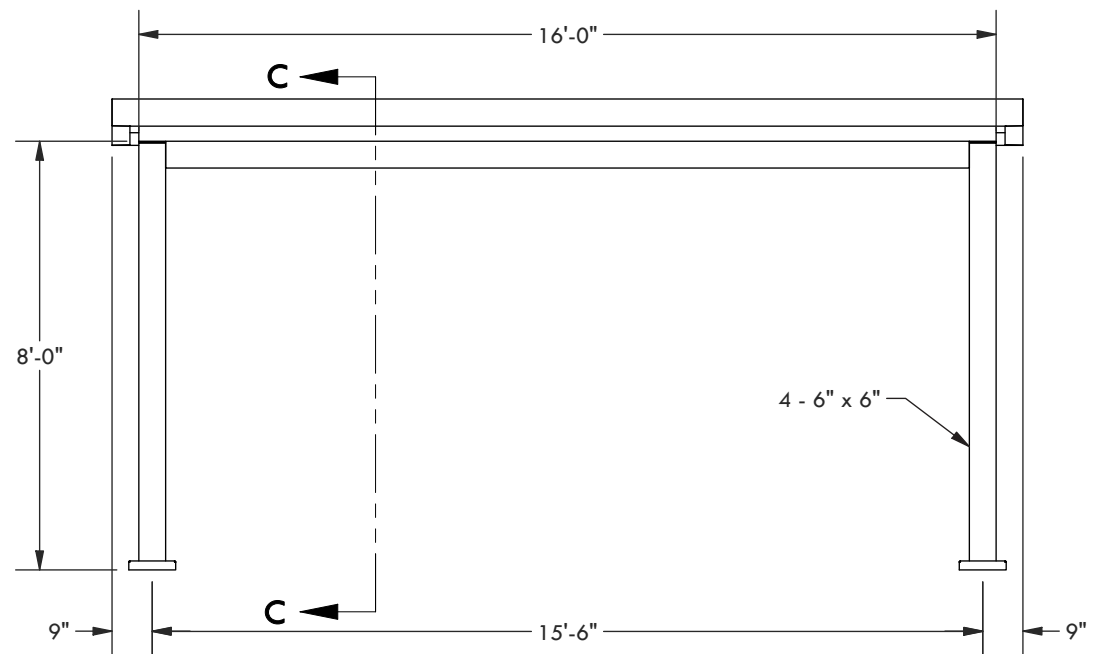
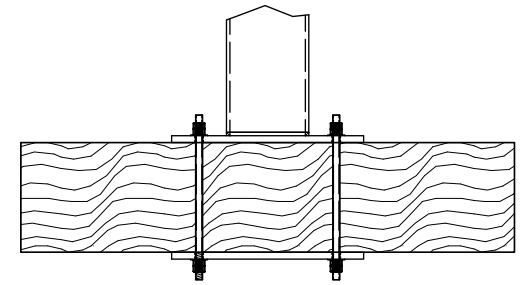

FRAMING MOUNT

DESCRIPTION			
16' WIDE x 16' PROJECTION FREESTANDING PAVILION			
REV	BY	DESCRIPTION	DATE
1	NB	INITIAL RELEASE	03/23/21

© 2021 Structureworks

STRUCTUREWORKS™
 www.structureworks.com 877.489.8064