

CONCRETE MOUNT

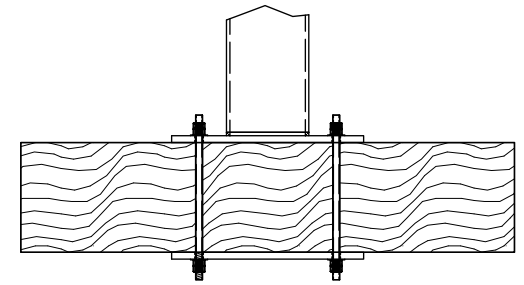

FRAMING MOUNT

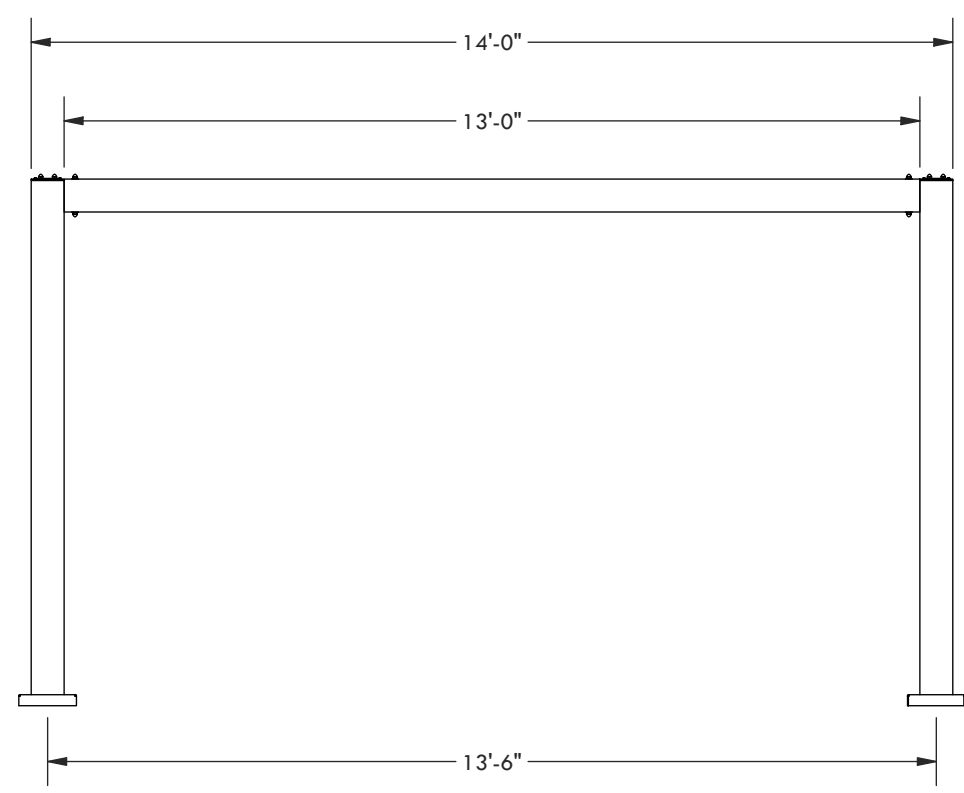
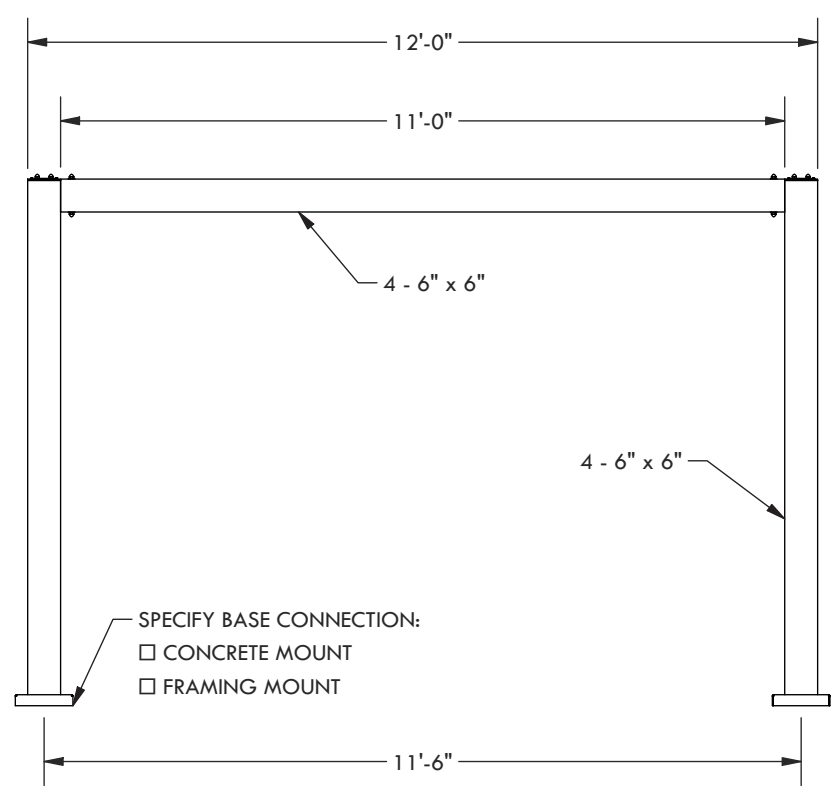

DESCRIPTION			
12' WIDE X 14' PROJECTION FREESTANDING ELEMENT			
REV	BY	DESCRIPTION	DATE
1	NB	INITIAL RELEASE	03/29/21
Trex® Pergola™			
www.trexpergola.com 888.908.4965			

© 2021 Structureworks