

SPECIFY FABRIC:

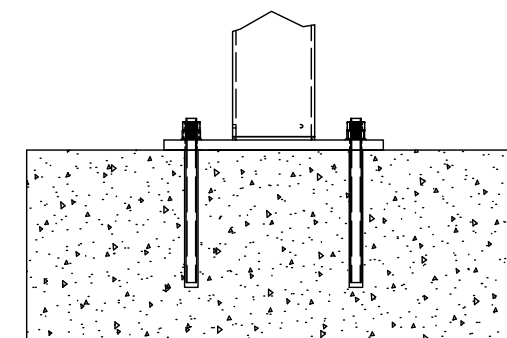

CONCRETE MOUNT

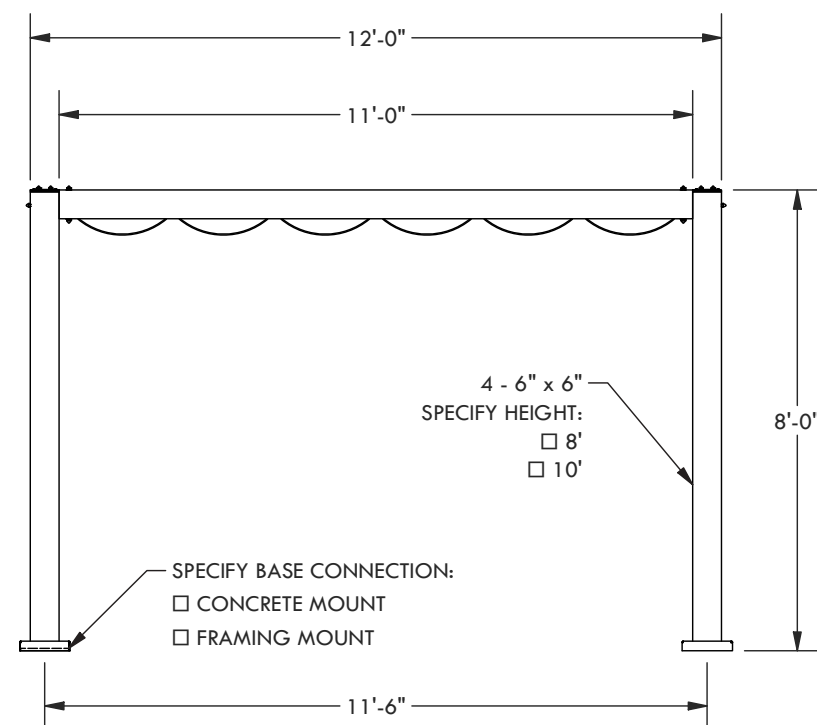
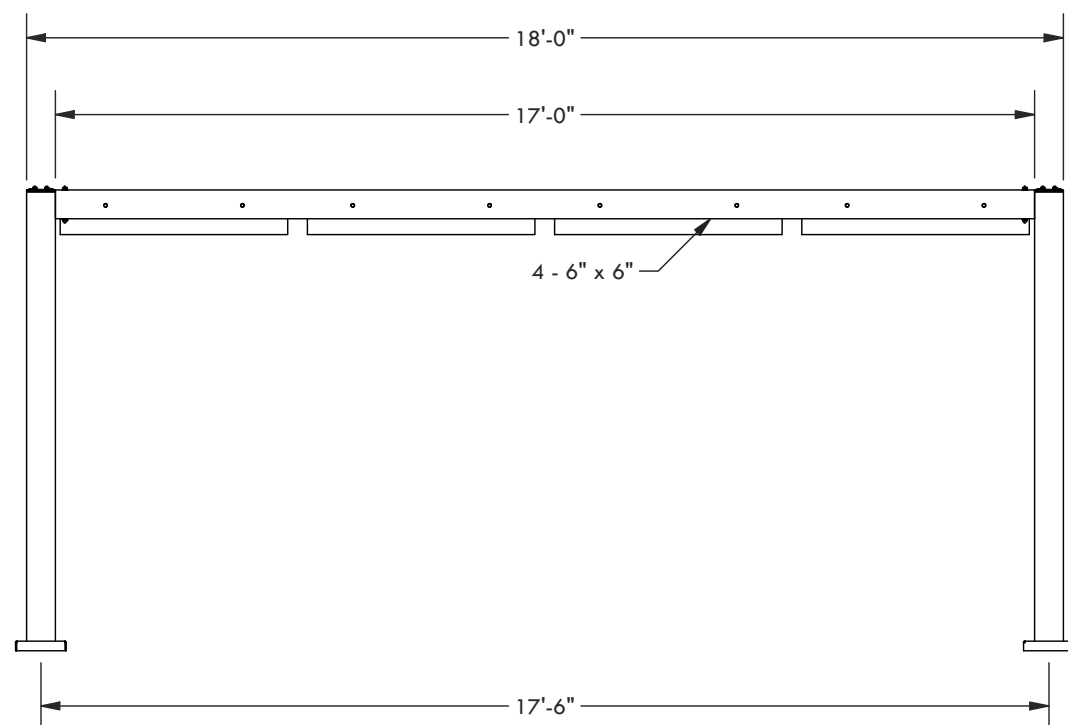
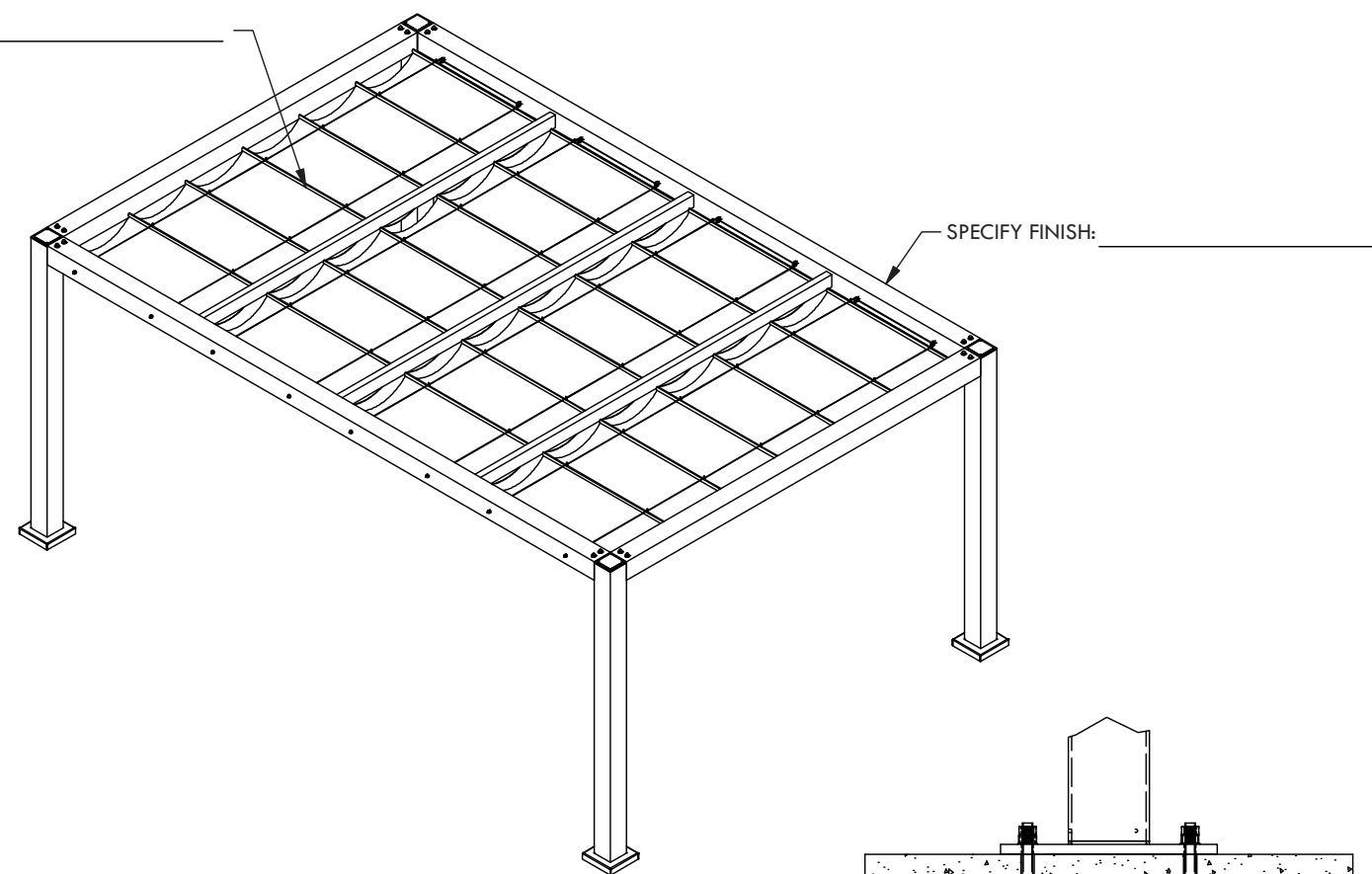
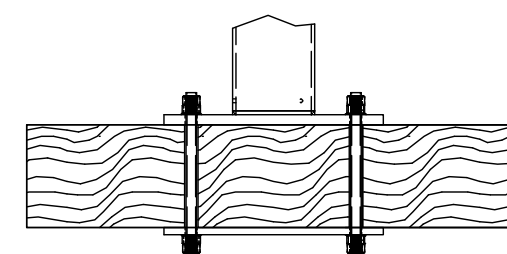

FRAMING MOUNT

DESCRIPTION			
18' WIDE X 12' PROJECTION FREESTANDING BREEZE			
REV	BY	DESCRIPTION	DATE
	PR	INITIAL RELEASE	03/09/23

© 2023 Structureworks

STRUCTUREWORKS™

www.structureworks.com 877.489.8064