

SPECIFY FABRIC:

SPECIFY FINISH:

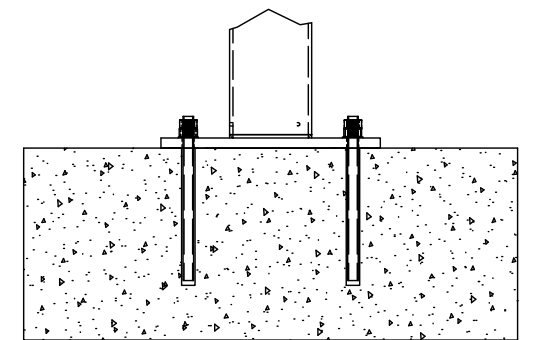

CONCRETE MOUNT

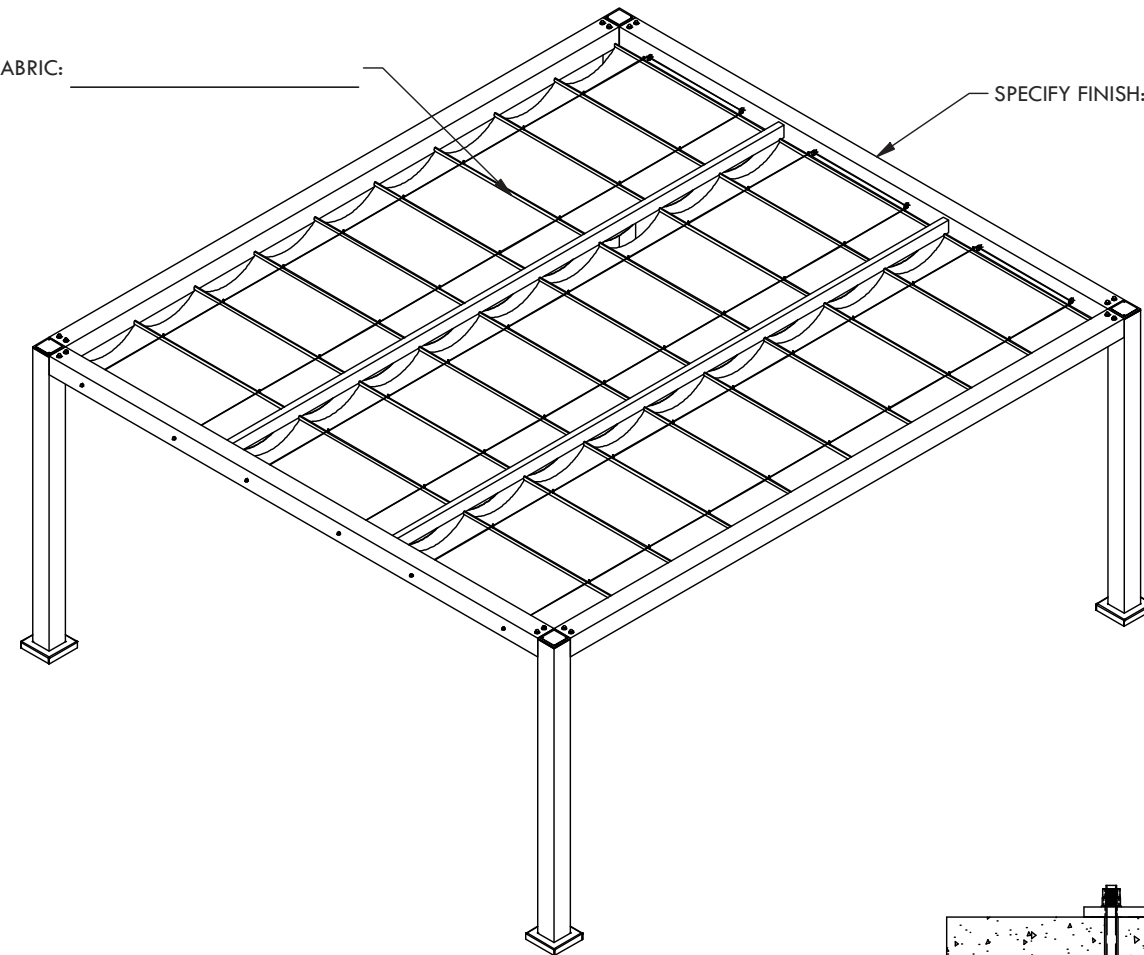
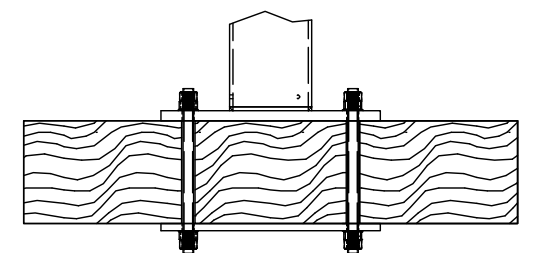

FRAMING MOUNT

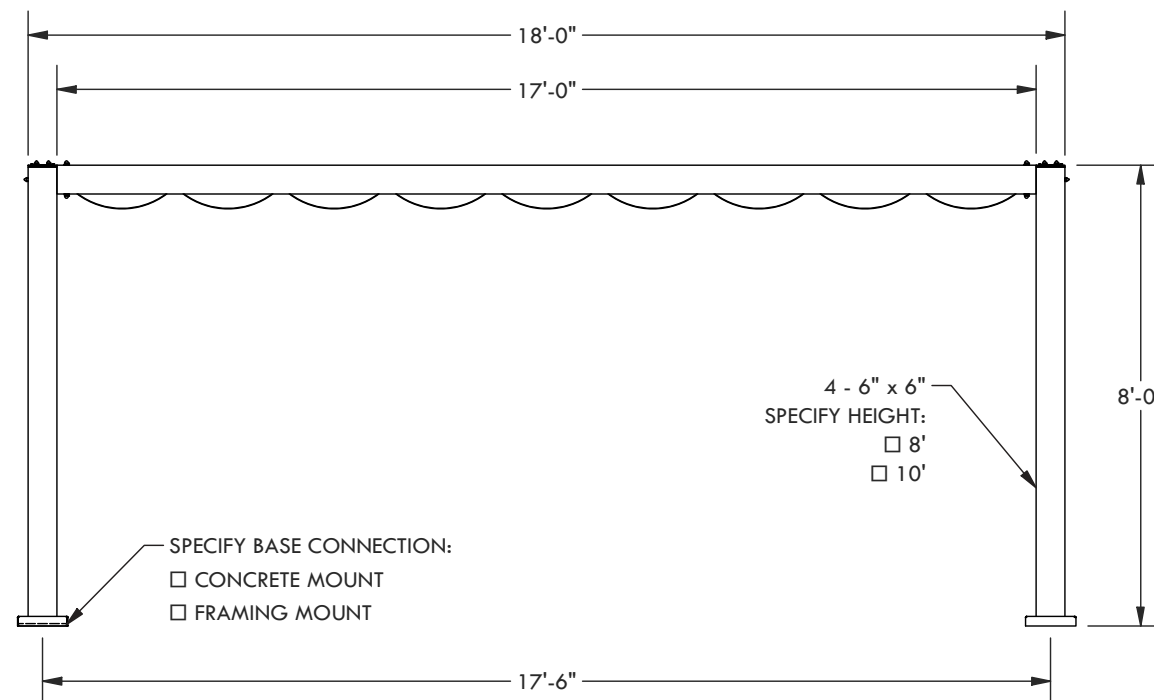
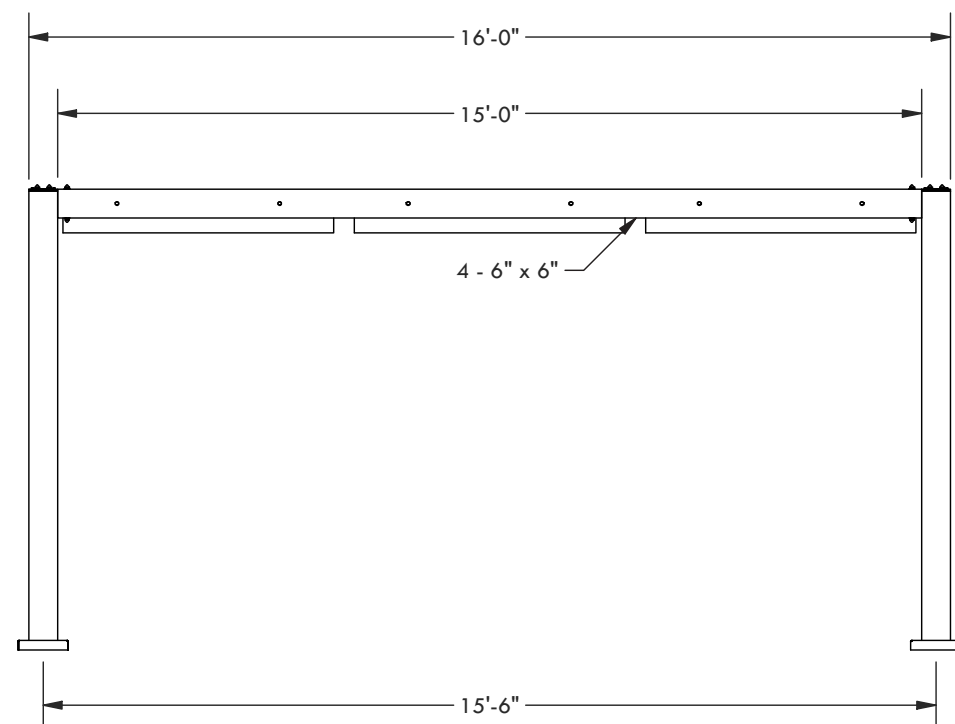

DESCRIPTION			
16' WIDE X 18' PROJECTION FREESTANDING BREEZE			
REV	BY	DESCRIPTION	DATE
	PR	INITIAL RELEASE	3/9/2023

© 2023 Structureworks

STRUCTUREWORKS™

www.structureworks.com 877.489.8064