

CLASSIC TRIM STANDARD TRIM

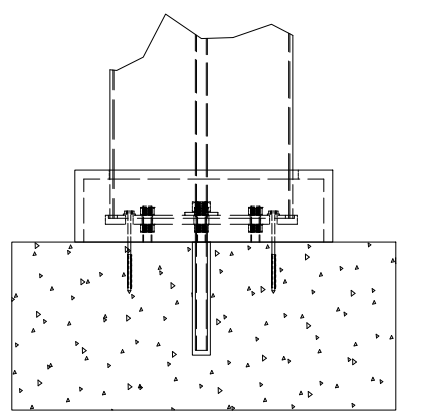

CONCRETE MOUNT

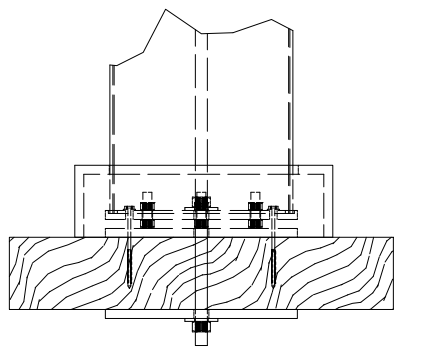

FRAMING MOUNT

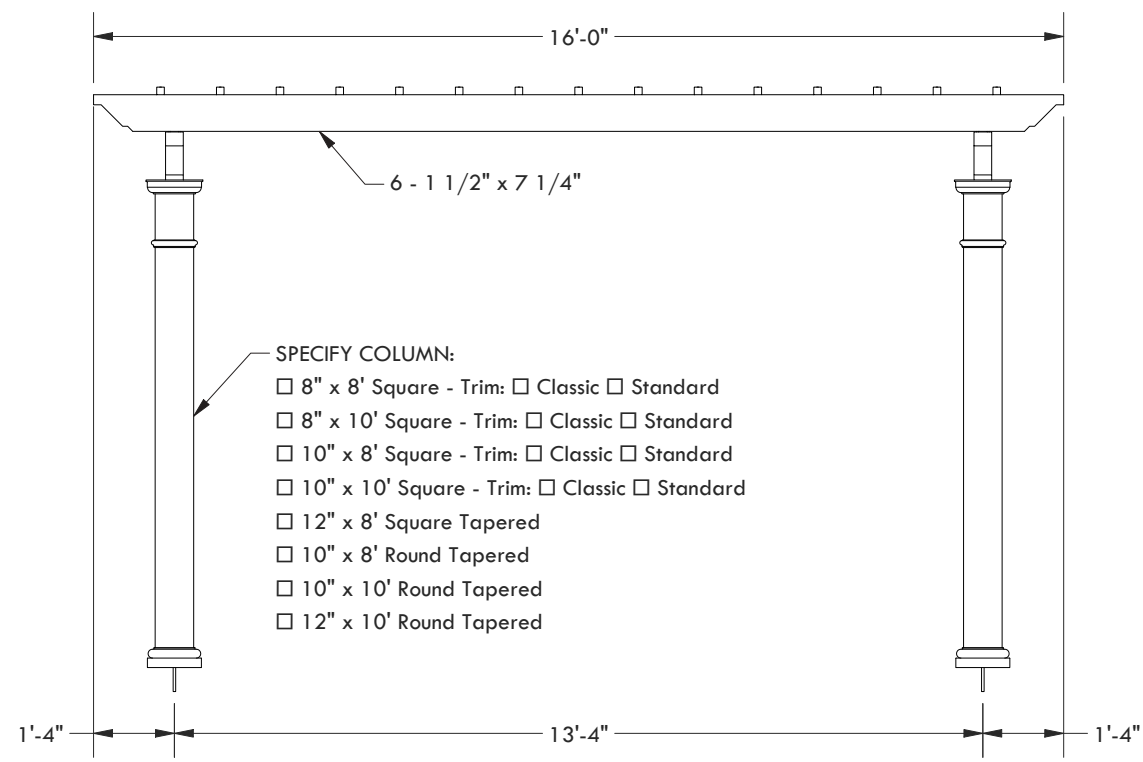
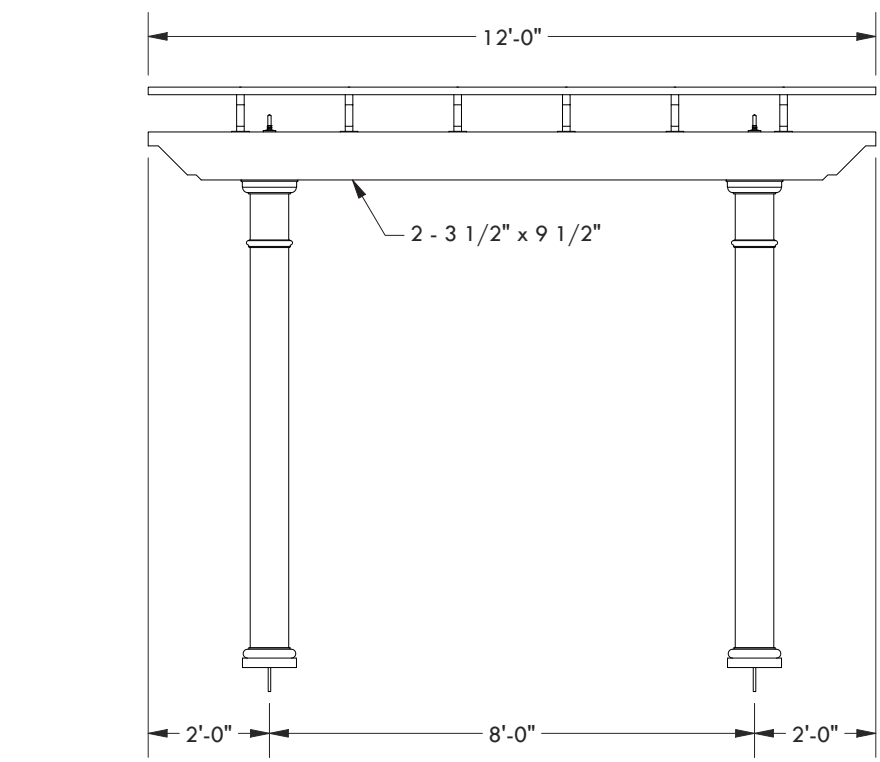

- SPECIFY COLUMN:
- 8" x 8' Square - Trim: Classic Standard
 - 8" x 10' Square - Trim: Classic Standard
 - 10" x 8' Square - Trim: Classic Standard
 - 10" x 10' Square - Trim: Classic Standard
 - 12" x 8' Square Tapered
 - 10" x 8' Round Tapered
 - 10" x 10' Round Tapered
 - 12" x 10' Round Tapered

© 2021 Structureworks

DESCRIPTION			
12' WIDE X 16' PROJECTION FREESTANDING TREX PERGOLA			
REV	BY	DESCRIPTION	DATE
1	NB	INITIAL RELEASE	03/24/21

Trex® Pergola™
www.trexpergola.com 888.908.4965