

CONCRETE MOUNT

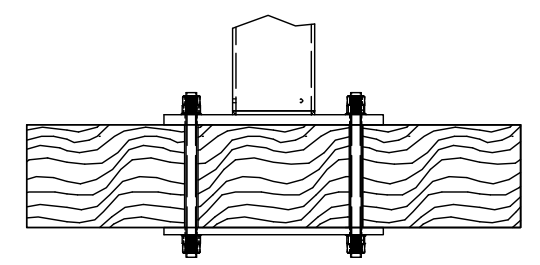

FRAMING MOUNT

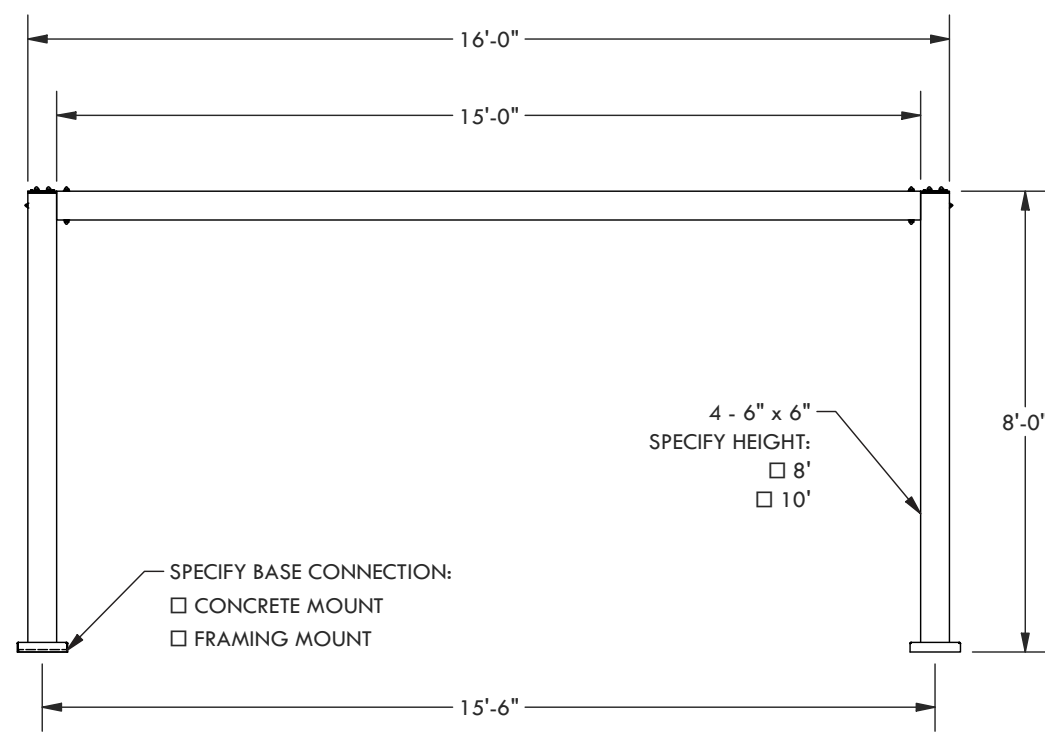
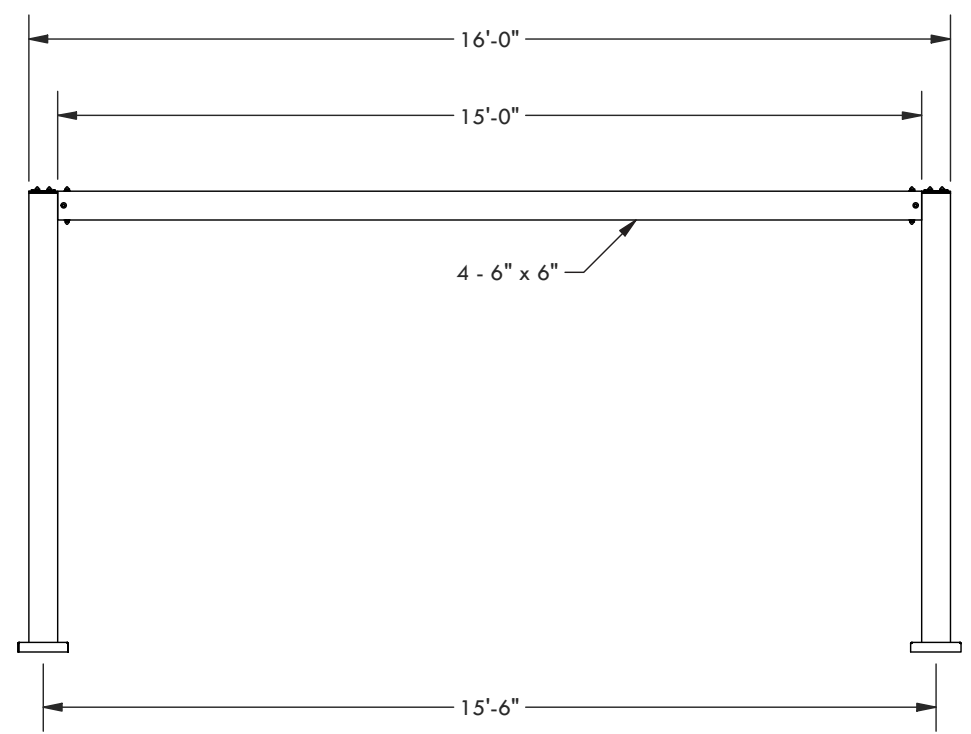

DESCRIPTION			
16' WIDE X 16' PROJECTION FREESTANDING SOLIS			
REV	BY	DESCRIPTION	DATE
	PR	INITIAL RELEASE	03/09/23

STRUCTUREWORKS™
 www.structureworks.com 877.489.8064

© 2023 Structureworks