

CONCRETE MOUNT

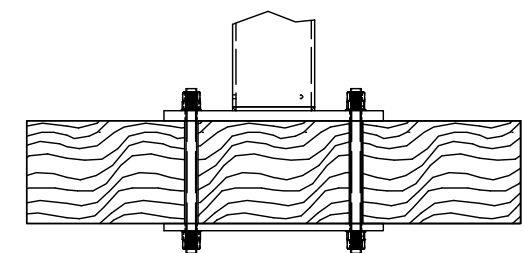

FRAMING MOUNT

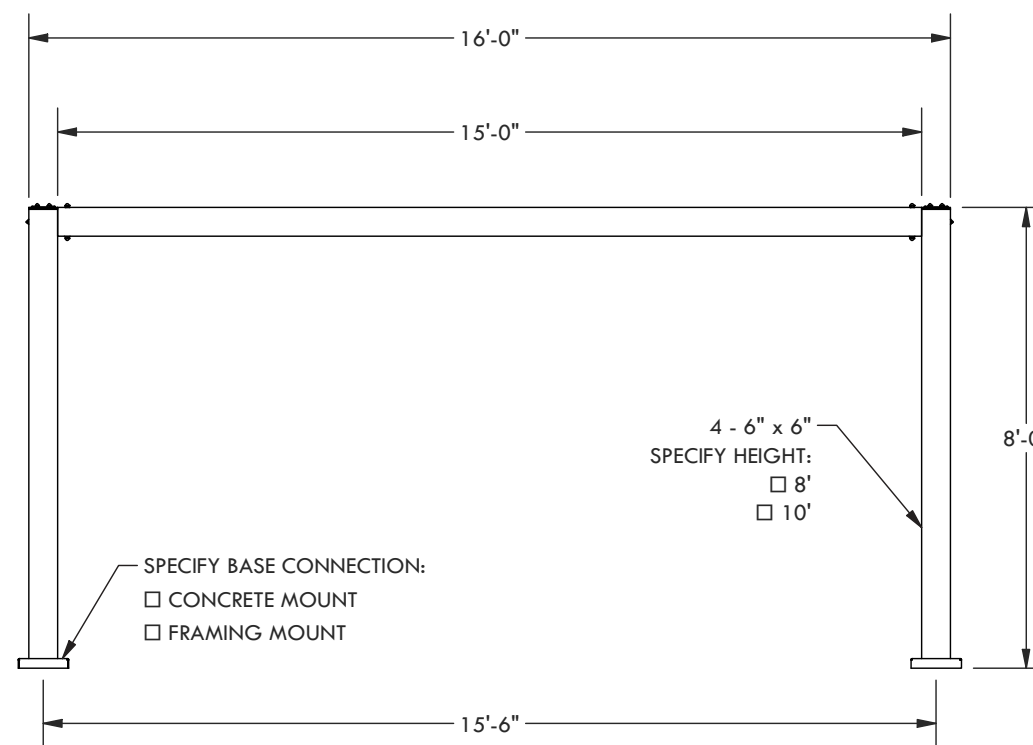
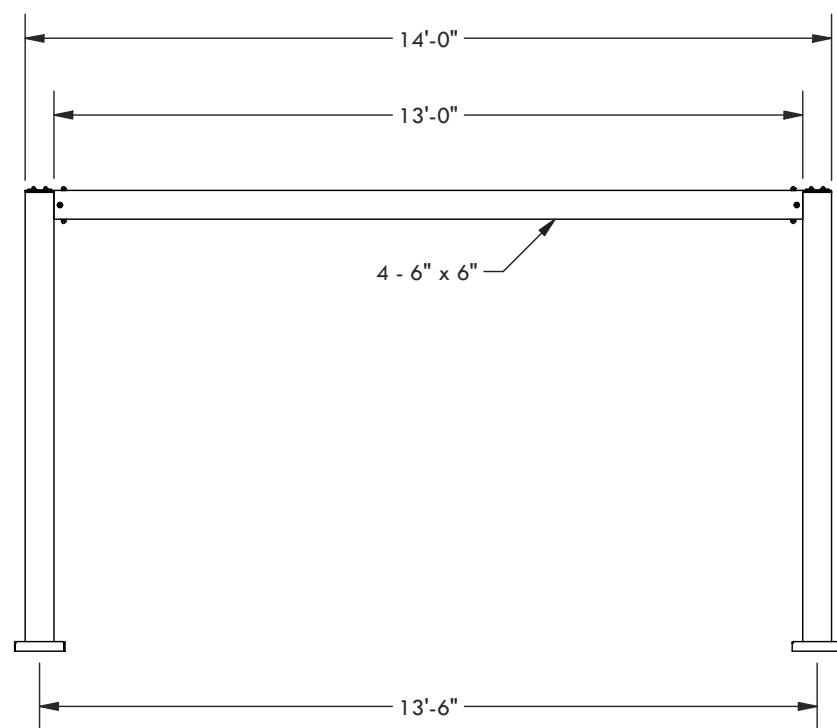

DESCRIPTION			
<b>14' WIDE X 16' PROJECTION FREESTANDING SOLIS</b>			
REV	BY	DESCRIPTION	DATE
	PR	INITIAL RELEASE	05/08/23

© 2023 Structureworks

**STRUCTUREWORKS™**

www.structureworks.com 877.489.8064