

CONCRETE MOUNT

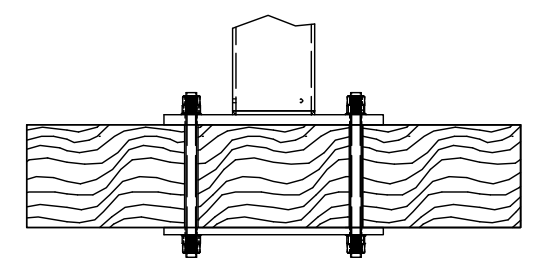

FRAMING MOUNT

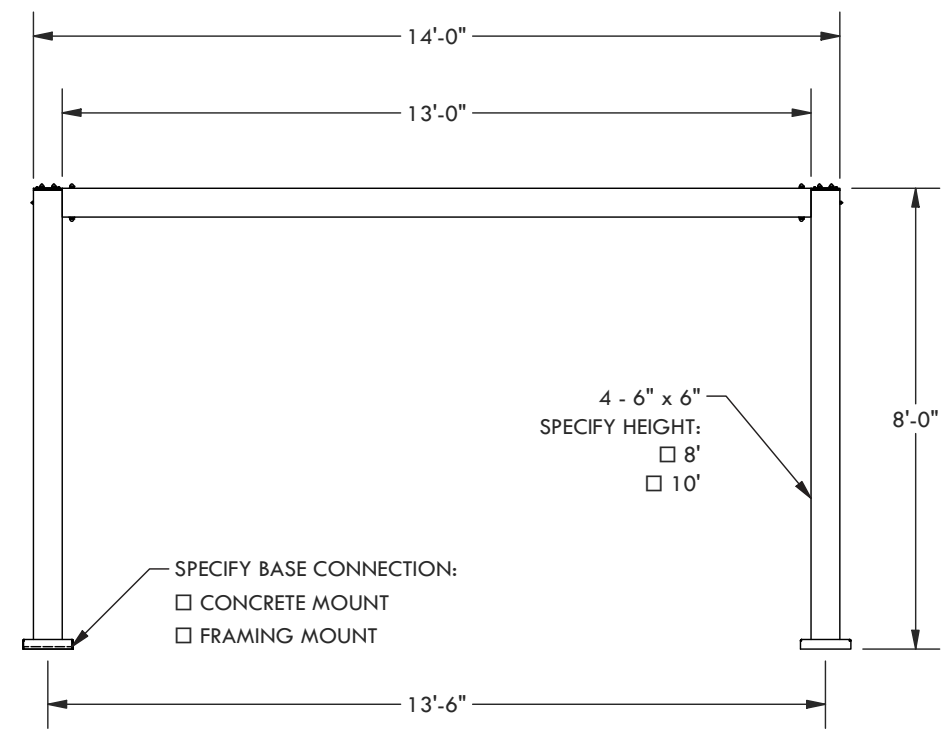
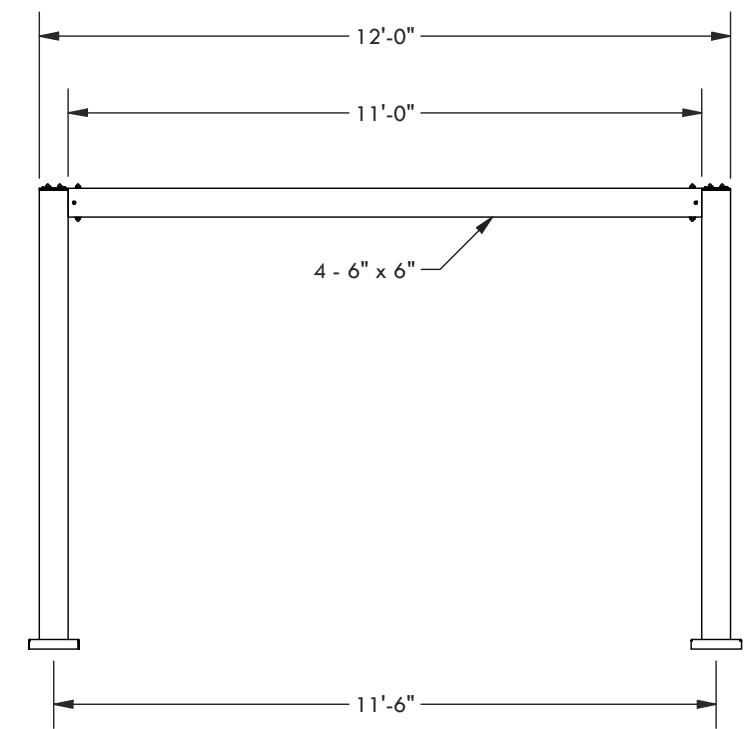

DESCRIPTION			
12' WIDE X 14' PROJECTION FREESTANDING SOLIS			
REV	BY	DESCRIPTION	DATE
	PR	INITIAL RELEASE	03/09/23
STRUCTUREWORKS™			
www.structureworks.com 877.489.8064			

© 2023 Structureworks